

ORION

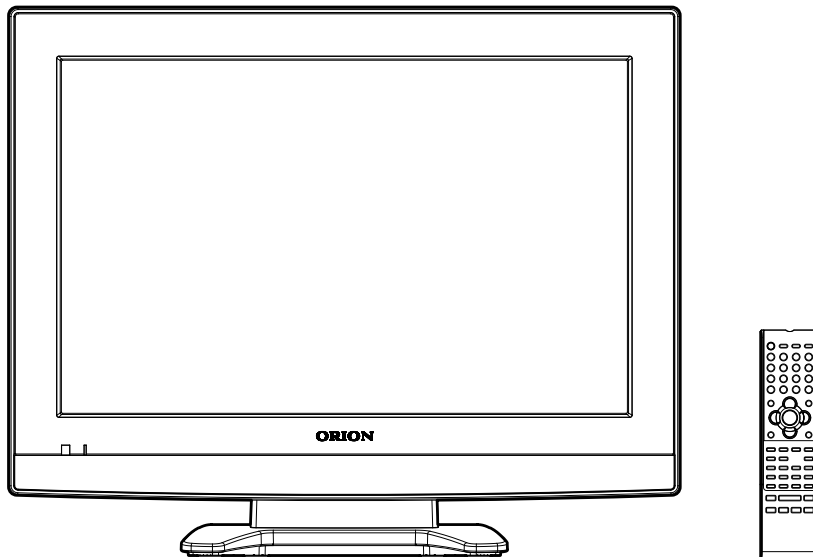



Instruction manual

19" DIGITAL LCD TELEVISION WITH DVD PLAYER

TV19PL120DVD TV19PL120DVD A

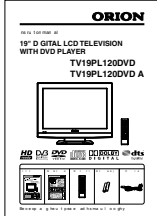
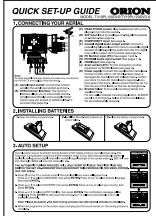

Accessories

Instruction manual	Quick Set-up guide	Remote control	Battery (R-6, AA) x 2	AC mains lead
				

Before operating the unit, please read this manual thoroughly.

Safety warnings

Damage - Never use your TV if it is damaged in any way. Always place your TV on a flat level surface avoiding anywhere which may be subject to strong vibration.

Weather - It is advisable to unplug the aerial during an electrical storm.

Moisture - Do not allow your TV to be exposed to rain, moisture or dust. If any liquid is spilt into your TV it can cause serious damage. If you spill any liquid into your TV switch it off at the mains immediately. Contact your store.

Interference
Do not place your TV on or near appliances which may cause electromagnetic interference (TV or Hi-Fi speakers). If you do, it may adversely affect the working of the unit, causing erratic playback, distorted picture or sound.

Temperature
Avoid extremes of temperature, either hot or cold, place your TV well away from heat sources such as radiators or gas/electric fires.

Ventilation
The TV must be well ventilated. Do not cover your TV or place inside a small confined space. It is recommended that you leave a 10cm gap all around your TV.

- Note:**
- When installing the set on a wall, allow at least 10 cm clearance between the rear of the set and the wall. Clearance of less than 10 cm will obstruct the vents and cause the interior of the set to overheat, resulting in faults or damage to the set.
 - If the unit is mounted on the wall, contact the shop where you purchased the unit for advice, and leave the installation work to experts. Incomplete installation work can cause you injuries.
 - The apparatus must be connected to a mains socket outlet with a protective earthing connection.
 - The socket outlet must be installed near the equipment and easily accessible.

* The "HD ready" Logo is a trademark of EICTA.

Batteries
Batteries are easily swallowed by young children. Do not allow young children to play with the remote control unit.

Covers - Do not remove any fixed covers as this may expose dangerous voltages.

Standby
Do not leave your TV in standby for long periods of time e.g. overnight or while on holiday. We recommend that you switch off / unplug at the mains power supply.

CAUTION:
THIS UNIT IS A CLASS 1 LASER PRODUCT. HOWEVER THIS UNIT USES A VISIBLE LASER BEAM WHICH COULD CAUSE HAZARDOUS RADIATION EXPOSURE IF DIRECTED. BE SURE TO OPERATE THE PLAYER CORRECTLY AS INSTRUCTED.

WHEN THIS UNIT IS PLUGGED INTO THE WALL OUTLET, DO NOT PLACE YOUR EYES CLOSE TO THE OPENINGS TO LOOK INTO THE INSIDE OF THIS UNIT.

USE OF CONTROLS OR ADJUSTMENTS OR PERFORMANCE OF PROCEDURES OTHER THAN THOSE SPECIFIED HEREIN MAY RESULT IN HAZARDOUS RADIATION EXPOSURE.

DO NOT OPEN COVERS AND DO NOT REPAIR YOURSELF. REFER SERVICING TO QUALIFIED PERSONNEL.

Plasma and LCD TV Screen Burn Warning

A characteristic of Plasma and LCD TV Panels is that displaying the same image for a long time may cause a permanent after-image to remain on the screen. This is called screen burn. Most pictures shown on your TV will be constantly moving and fill the screen.

Examples of images that you need to watch out for are as follows (this is not an all-inclusive list):

- **Black Bars:** If black bars appear at the left/right or top/bottom of the screen it is recommended to change the format so that the picture fills the entire screen.
- **TV Channel Logos:** e.g. Shopping channel logos and pricing displays - especially if they are bright and stationary. Moving or low-contrast graphics are less likely to cause ageing of the screen.
- **PIP and Multitip:** Do not view for long periods of time using the PIP or Multitip functions.
- **Time Displays**
- **Teletext:** Do not view a stationary page for long periods of time.
- **TV/DVD Menus:** e.g. Listings of DVD disk content.
- **Pause Mode:** Do not leave the screen in pause mode for long periods of time, e.g. When watching DVDs or videos.

Note: To prevent screen burn if viewing any of the above for long periods of time, reduce contrast and brightness when viewing. Once burn-in occurs it will never disappear completely.

Attention!
Cleaning instructions for your LCD TV.

Safety note:
Before you start to clean, switch the set's power off completely and disconnect the plug from the mains power supply.
Be careful not to scratch the plastic coated front panel - it is highly vulnerable to accidental scratching (e.g. by fingernails or other sharp items).
While cleaning, do not wear jewellery that could cause surface scratching (such as rings, wrist-watch, etc.).

Use a lint-free cloth and pure water to clean with, but make sure the cloth is thoroughly wrung out so that it is just damp and not soaking wet - also make sure that the cloth is free from any dirt that could cause scratching to the surface.

Wipe the set clean using minimal pressure.
Do not use standard window cleaning fluid. Its alcohol / ammonia will dissolve the front window's coating.

Never use solvent or thinner. Never use special cleaners which are designed for cleaning PC Monitors or CRT TVs.
Finally carefully rub dry with a clean dry lint-free cloth.

Do not use paper towels or tissues to clean the set - paper can disintegrate when wet or may leave a trail of dust behind. Some paper can also be abrasive and scratch your screen.

Moving the unit or carrying by hand

When the unit is moved a long way, unplug the power cord and disconnect the aerial, connecting leads and any fall-prevention apparatus.

- Moving without doing so could result in damage to the power cord, a fire, electric shocks or injuries from dropping the unit.

The distance between eyes and the screen should be about 5 ~ 7 times as long as diagonal length of the screen.

- Viewing from too close a distance can cause strain for your eyes.

When installing the Monitor on a table, be careful not to place the edge of its stand.

- This may cause the Monitor to fall, causing serious injury to a child or adult, and serious damage to the Monitor.



Contents

Location of controls	Page 2	Channel list	Page 26
Aerial connection	Page 3	Channel banner	Page 27
Connection to other equipment	Pages 4-6	Multi audio	Page 28
PC Connection	Pages 7-8	DVB-Subtitle	Page 28
Connecting an HDMI or a DVI device to the HDMI input	Page 9	DVB Text	Page 29
Analogue Menu System	Page 10	EPG (Electronic Program Guide)	Page 30
On-screen Language Selection	Page 10	EPG Timer	Page 31
Auto setup	Page 11	Disc	Page 32
Auto tuning	Page 12	Playing a disc	Pages 33-35
Changing the order of stored channels	Page 12	Zooming	Page 36
Manual tuning	Page 13	Locating Desired Scene	Page 36
Basic TV functions	Page 14	Marking desired scenes	Page 37
Teletext	Page 15	Repeat Playback	Page 38
Adjusting the NICAM stereo sound	Page 16	A-B Repeat Playback	Page 38
Picture format	Page 17	Changing Angles	Page 39
Other useful functions	Page 18	Title Selection	Page 39
Guide to using the Digital Menu System	Page 19	DVD Menu	Page 39
Language Setup	Page 20	Changing Soundtrack Language	Page 40
Auto Scan	Page 20	Subtitles	Page 40
Manual Scan	Page 21	Disc Status	Page 40
Carrier Setup	Page 21	MP3/WMA/JPEG and Audio CD operation	Pages 41-45
Channel Organizer	Pages 22-23	Program playback	Page 46
Display Setup	Page 24	Random playback	Page 46
Password Setup (Parental lock)	Page 24	Customizing The Function Settings	Pages 47-50
Version	Page 25	Temporary Cancel The Rating Level By DVD Disc	Page 51
Software Upgrade	Page 25	Language Code List	Page 52
Common Interface	Page 25	Before Requesting Service	Pages 53-54
		Specifications	Page 55

Location of controls

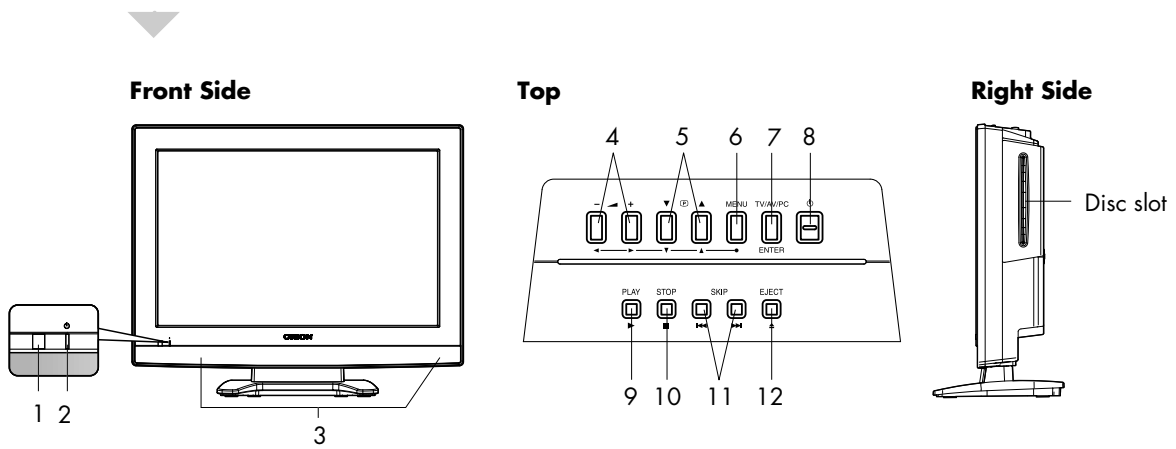

Description of Indicators and Controls

1. **Remote sensor**
2. **STANDBY/TIMER/ON indicator:** The LED indicator lights up red in STANDBY mode, green in the POWER ON mode.
3. **Loudspeakers**
4. **▲ (VOLUME) +/- Buttons:** To adjust the volume. When the Menu is on the screen, these are used for changing settings.
5. **Ⓟ (CHANNEL) ▲/▼ Buttons:** Press ▲ to move up a channel number. Press ▼ to move down a channel number. When the Menu is on the screen, these are used for changing settings. When the set is in standby, they can also be used to switch the power on.
6. **MENU Button:** To display the menu screen.
7. **TV/AV/PC Button:** Selects between the TV/AV/PC input modes.
8. **Ⓞ (STANDBY) button:** To switch between the STANDBY and POWER ON modes.
9. **PLAY (▶):** Playback
10. **STOP (■):** Stop
11. **SKIP (◀◀/▶▶):** Skip chapter to forward or reverse direction.
12. **EJECT (▲):** Eject a disc.

Remote Control

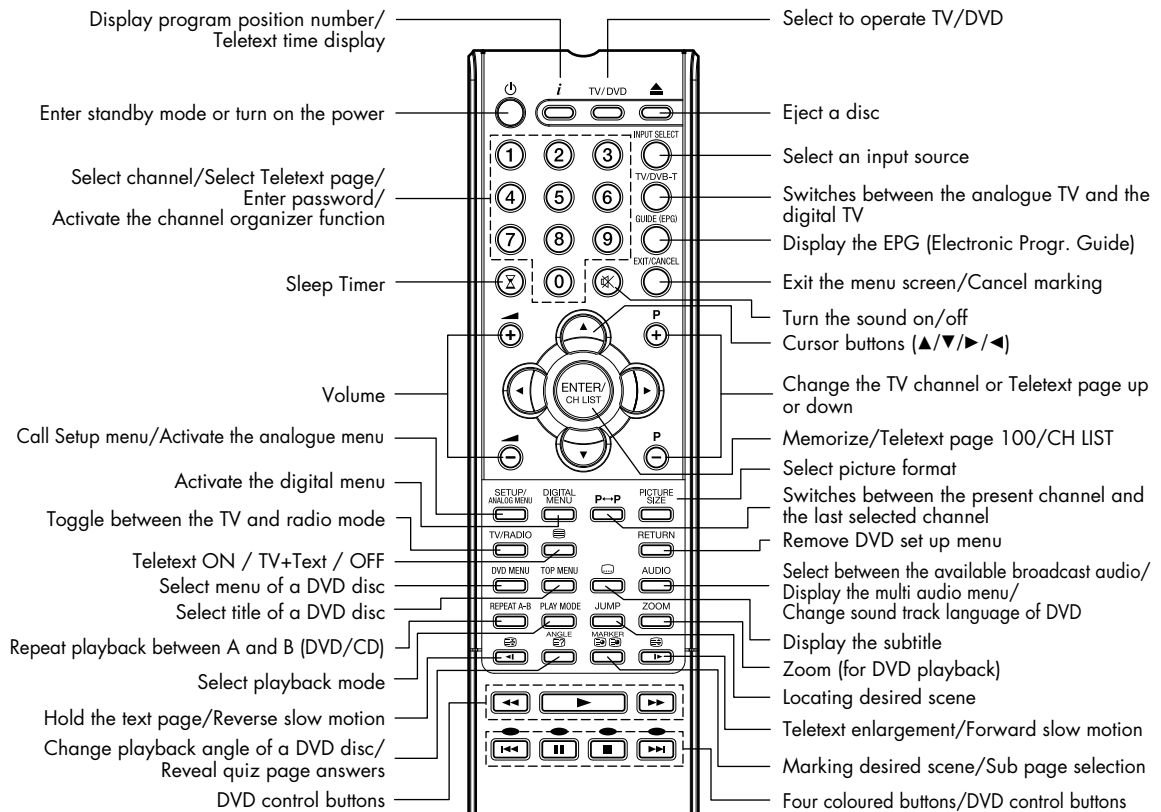

Aerial connection

Note: To avoid possible damage, before you make any connections, turn off the TV at the **(STANDBY)** button and unplug it from the mains. Once the connections are in place, re-connect the unit to the mains and switch it back on.

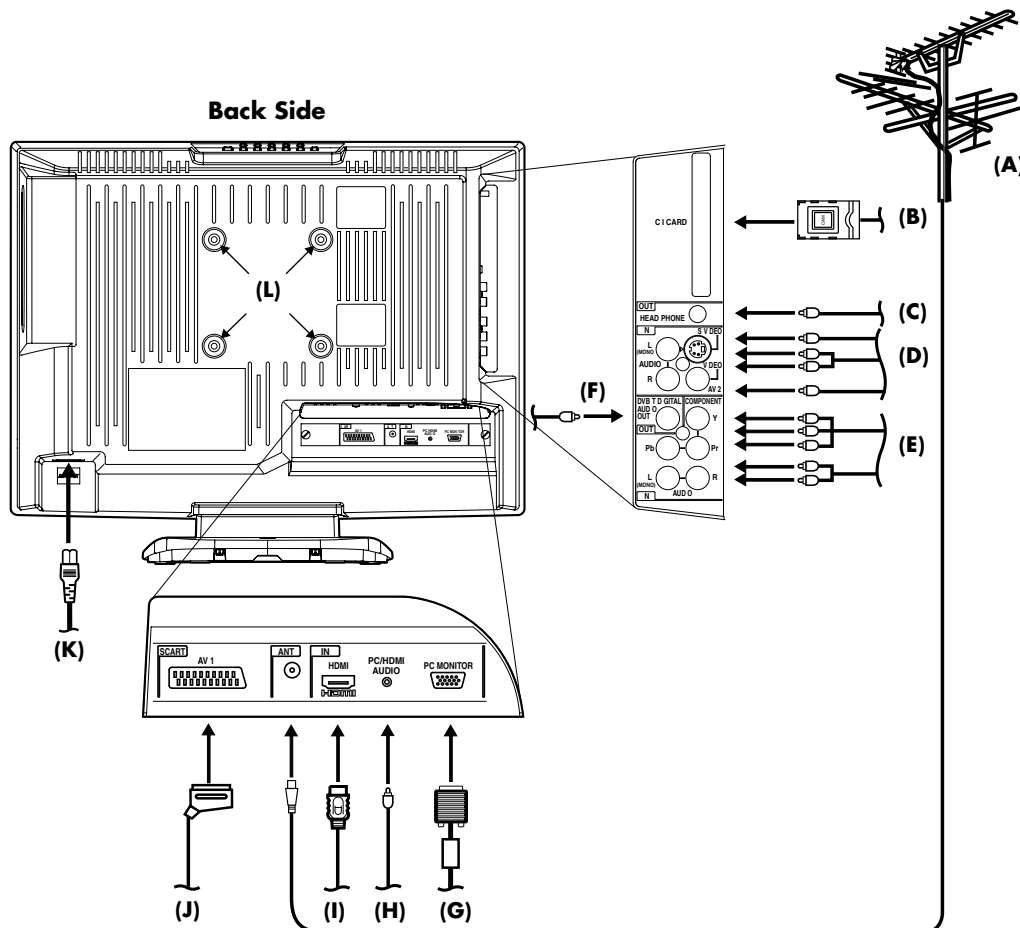

- (A) Aerial input socket:** Connect the outdoor aerial to the aerial input socket as shown.
- (B) DVB Common Interface:** The Common Interface allows you to insert CAM (Conditional Access Module) and a suitable Smart Card to give you access to additional Pay-TV services (See page 25).
- (C) HEAD PHONE socket:** Plug headphones with a mini plug (3.5 mm) into this socket.
- (D) AV2 input:** Input for analogue A/V-Signal (Composite or S-Video). See page 5.
- (E) COMPONENT input:** See page 6.
- (F) Coaxial digital audio output socket:** Connect a coaxial digital audio lead from here to a suitable digital decoder/amplifier. Only the audio from the TV's digital tuner will be output via this socket (see page 5).
- (G) PC Monitor input (PC):** See pages 7 and 8.
- (H) PC/HDMI Audio input socket:** See pages 7, 9.
- (I) HDMI input:** See page 9.
- (J) Scart socket (AV1):** For the connection of other equipment via SCART leads (see page 4).
- (K) Power supply:** Connect the supplied AC mains lead. Connect to 220~240 V / 50 Hz only. Never repair a damaged AC mains lead with isolation tape - contact your store if a new AC mains lead is required. If you have pets in the home, please ensure that they do not bite into any of the leads, as this can be dangerous.
- (L) Bracket holes:** To fix a wall mounting bracket (not supplied) here.
For any wall or bracket mounting application, ALWAYS use all 4 of the fixings - failure to do this could leave the set inadequately secured.

Connection to other equipment

Selecting the video input source:

Press **INPUT SELECT** on the remote control or **TV/AV/PC** on the unit. The INPUT SELECT menu will appear. Then press **▲/▼** to select the video input source. Then press **ENTER** within 6 seconds.

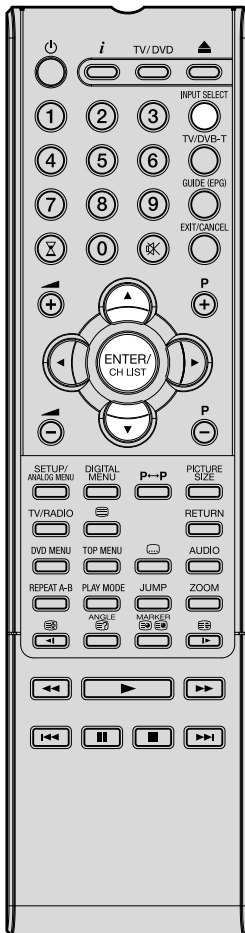
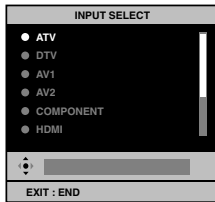

1

Examples of other AV equipment that you might connect to this TV

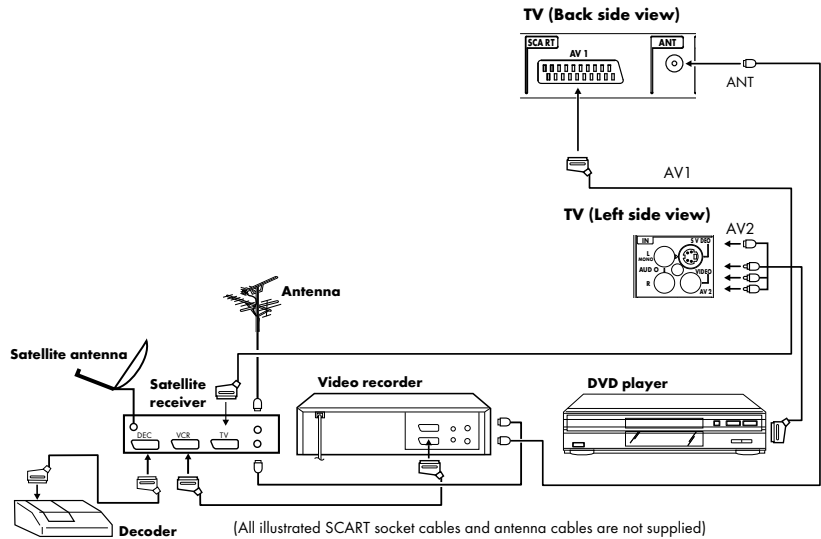

- Make sure to disconnect the appliance from the power supply in order to avoid any potential damage from occurring.
- Make sure to establish the required connection.
- Make sure that connections are properly and correctly attached before connecting the appliances to the power supply.

2

Connecting a decoder

TV (Back side view)

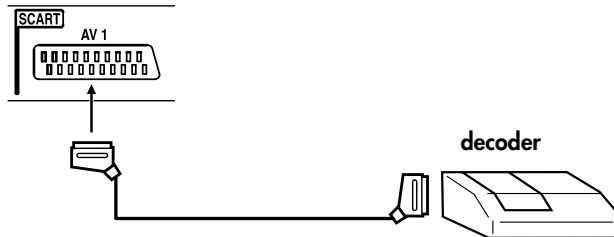

(Illustrated SCART socket cable is not supplied)

You can use the AV1 SCART socket when connecting a decoder and other audiovisual equipment.

Connection to other equipment

3

Connecting an audio system

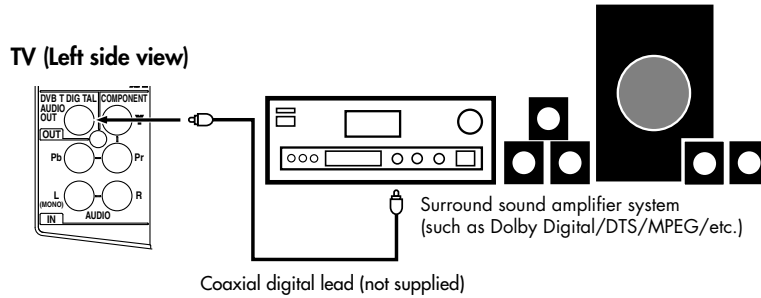

The exact arrangement you use to interconnect various video and audio components to the unit is dependent on the model and features of each component. Check the Owner's Manual provided with each component for the location of video and audio inputs and outputs.

4

Connect to a Video camera or games console

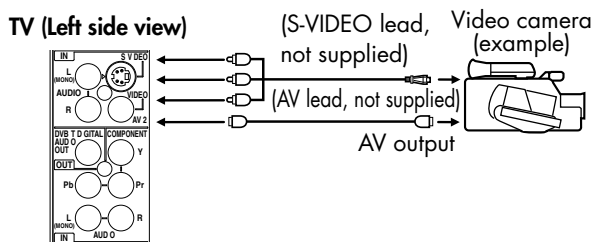

Connect the Video camera (or games console) to the TV unit using the appropriate RCA / Phono AV leads (or S-Video if applicable). Select AV2-input mode (see page 4).

Note:

- If you have a camcorder with S-video, use an S-video lead instead of a standard video lead. Do not connect both a standard video lead and an S-video lead at the same time, or the picture performance will be unacceptable.

Connection to other equipment

Note:

- The Component Video inputs on this unit can accept both interlaced signals (PAL: 576i/1080i or NTSC: 480i/1080i) and progressive signals (PAL: 576p/720p or NTSC: 480p/720p).

SETUP menu

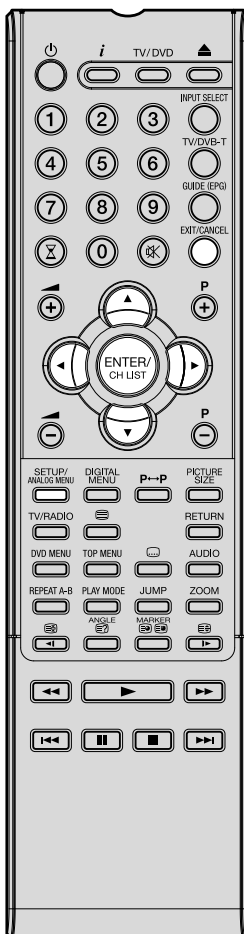
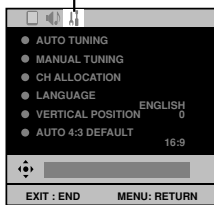

5

Connecting to a DVD player or other AV device with Component Video outputs

TV (Back side view)

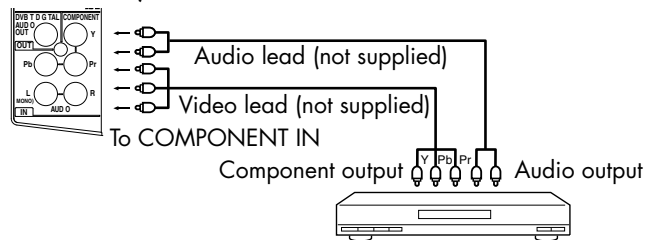

If your DVD player (or other device) has Component Video output sockets, use a suitable set of leads (RCA/Phono) to connect these to the Component Video inputs on this TV as shown - it can greatly enhance the picture quality and performance. Please remember that you will also need to connect separate leads (RCA/Phono) for the audio signals. To view this source, select the COMPONENT input mode (see page 4).

6

Selecting the setting for the SCART socket

- Press **ANALOG MENU**, the menu will appear on the screen. Press ◀ or ▶ to select (SETUP) menu. Press ▲ or ▼ to select AV1 OUTPUT, then press **ENTER**.
- Press ◀ or ▶ to select TV or MONITOR, then press **ENTER**.
 - TV:** Outputs the last channel position selected on RF.
 - MONITOR:** Shows the picture displayed on the TV-screen.
- Press **EXIT** to return to the normal screen.

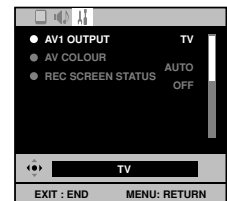

PC Connection

Use a PC-VGA lead (not supplied) to connect your PC to this unit. Plug the lead carefully not to break or bend the contact inside of plug.

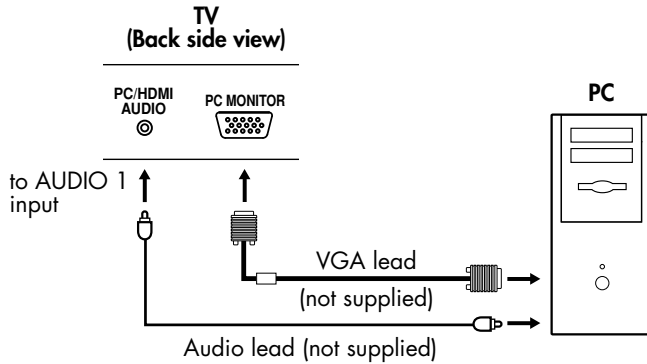

Select PC input

Press **INPUT SELECT** and press **▲** or **▼** to select PC, then press **ENTER**. PC appears on the TV screen.



Note:

- If there is no video signal from the computer when the unit is in PC mode, 'NO SIGNAL' will appear on the TV-screen.
- See next page for PC mode menu.

Monitor Display modes

MODE	Resolution	Refresh rate
VGA	640x480	60Hz
VGA	720x400	70Hz
SVGA	800x600	60Hz
XGA	1024x768	60Hz
WXGA	1280x720	60Hz
WXGA	1280x768	60Hz
WXGA	1360x768	60Hz

(according to Graphic card)

PCs are usually supplied with a 'normal' CRT monitor (Cathode Ray Tube).

Before you connect this unit to your PC, change the adjustment of your PC's graphic card.

Otherwise the picture may not appear correctly on the unit. Turn on your PC (still with your old Monitor) and select under 1360 x 768 for on-screen graphic resolution.

Select under 60 Hz for on-screen refresh rate. Switch off your PC, then connect it to this unit while both items are still switched off.

Note:

- Digital PC-connection via HDMI input is not supported. If you try to connect your PC digitally anyway, the TV-operation might freeze. TV will stop to respond properly on usercommands.

Countermeasure:

Switch-off your TV and disconnect from the 220~240V-power-supply. Disconnect the digital PC-connection.

Now you may retry operating your TV.

- If a digital PC-connection does show a picture, proper working is not guaranteed. Digital PCconnection is not granted for this TV.

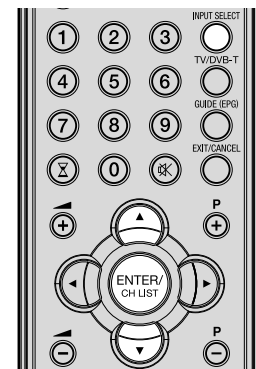

PC Connection

Note: The PC mode menu settings are not effective for normal TV-mode or external input mode.

Example: Adjust the brightness.

1
During PC mode press **ANALOG MENU**.
The menu appears on the TV-screen.
Press ◀ or ▶ to select  (PICTURE) menu.



2
Press ▲ or ▼ to select BRIGHTNESS, then press **ENTER**.
Then press ◀ or ▶ to adjust the brightness, then press **ENTER**.

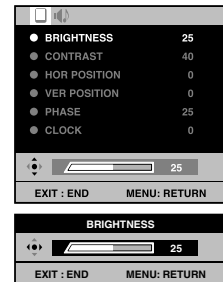

PICTURE (PC) menu

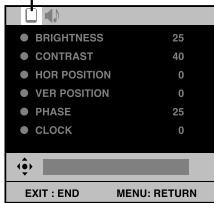

3
Press **EXIT** to return to the normal screen.

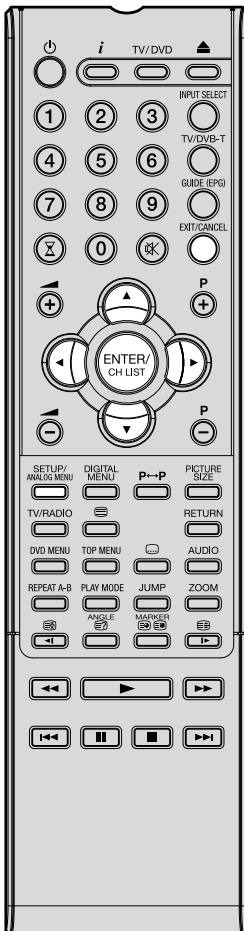

Description of each setting option:

PICTURE menu

BRIGHTNESS and CONTRAST: can be set as you are accustomed to your TV.

HOR POSITION and VER POSITION: to adjust the horizontal and vertical placing of the image.

PHASE and CLOCK: eliminates the horizontal (PHASE) and vertical (CLOCK) interfering lines.

RED/GREEN/BLUE: influences the colour balance.

BACKLIGHT: Press ◀ or ▶ to adjust the level you require.

WXGA INPUT: When you input WXGA, set this option to 'ON'.

RESET: Press **ENTER** to reset BRIGHTNESS, CONTRAST, RED, GREEN, BLUE and BACKLIGHT to the factory preset values.

AUDIO menu

BASS/TREBLE/BALANCE: Tone setting menu.

RESET: Press **ENTER** to reset BASS, TREBLE and BALANCE to the factory preset values.

Connecting an HDMI or a DVI device to the HDMI input

The HDMI input receives digital audio and uncompressed video from an HDMI equipped device or uncompressed digital video from a DVI equipped device. When you connect to a DVI device with a HDMI-to-DVI adapter lead, it only transfers the video signal, so it is necessary to use separate analogue leads (RCA/Phono type) to transfer the audio signals. Select the HDMI input mode (see page 4).

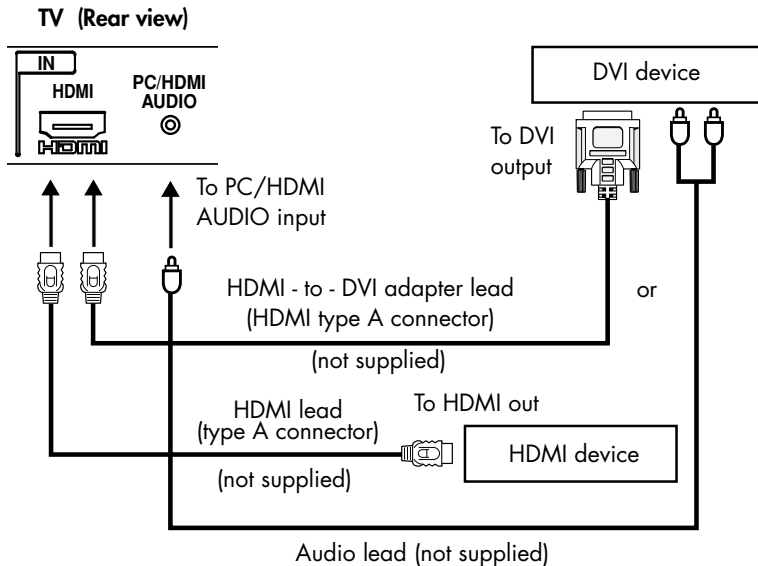

HDMI, the HDMI logo and High-Definition Multimedia Interface are trademarks or registered trademarks of HDMI Licensing LLC.

HD ready This set is classed as "HD-Ready". This means that it is capable of displaying HD (High Definition) signals when connected to a suitable HD source, such as an HD receiver or DVD player that has HD capability, via HDMI, DVI, or Component Video connections.

Note:

- Some devices may not operate properly with the TV.

Details of HDMI input signals

HDMI compliant (type A connector), HDCP compliant
 Suggested scan rates: PAL: 576i/576p/720p/1080i
 NTSC: 480i/480p/720p/1080i
 HDMI Audio: 2-channel PCM, 32/44.1/48 kHz sampling frequency
 16/20/24 bits per sample

Selecting the HDMI audio input source

You must choose the appropriate HDMI audio input setting for each connection, depending on whether the source is equipped with a DVI or HDMI socket.

1

Press **ANALOG MENU**, the menu will appear on the screen. Press ◀ or ▶ to select **(AUDIO)** menu.

Press ▲ or ▼ to select **HDMI AUDIO**, then press **ENTER**. Then press ◀ or ▶ to select **HDMI** or **DVI**, then press **ENTER**.

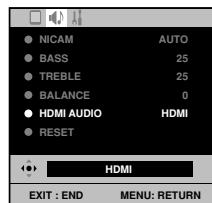

2

Press **EXIT** to return to the normal screen.

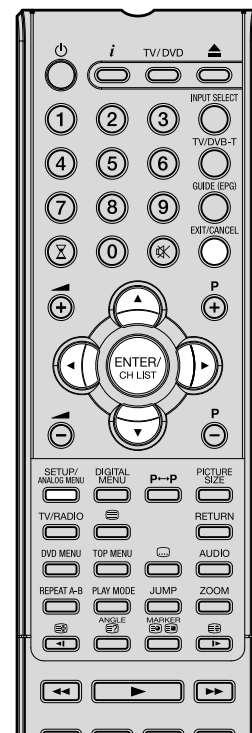

Analogue Menu System/On-screen Language Selection

Note:

- If no buttons are pressed for more than approx. 60 seconds, the menu disappears automatically.
- If you have already successfully selected your preferred language at the Automatic Tuning stage, you don't need to go through the procedure below to select it.

Preparation

Turn on the unit with **⏻ (STANDBY)** on the top of the unit or press **⏻ (STANDBY)** on the remote control.
 You can also turn the unit on with **⏻ (CHANNEL) ▲ or ▼** on the unit or **P +** or **P -** on the remote control.
 To turn off the unit press **⏻ (STANDBY)** on the unit or press **⏻ (STANDBY)** on the remote control - to completely switch it off, disconnect the mains power supply.
 Press **TV/DVD** to select TV mode, or press **INPUT SELECT** and press **▲ or ▼** to select ATV, then press **ENTER**.

Analogue Menu System

Make sure the antenna and power supply are correctly connected according to the instructions on page 3.

1

Press **ANALOG MENU**, the menu will appear on the screen.

Press **◀ or ▶** to view the 3 menu options
□ (PICTURE), **🔊** (AUDIO), **⚙️** (SETUP).

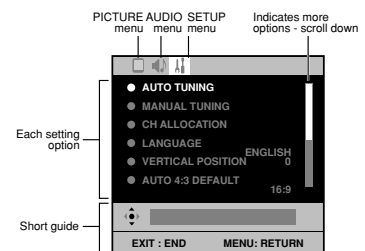

2

Press **▲ or ▼** to select whichever item you require. The function can be activated by pressing **ENTER**.

Note:

- Some of the menus have more than one page of items - a scroll bar indicates that you can scroll down or up to select other items.

3

Press **EXIT** to return to the normal screen.

On-screen Language Selection

This TV has 13 different languages for menu set up which can be selected through the On-Screen Display: English, German, French, Spanish, Italian, Dutch, Portuguese, Swedish, Finnish, Polish, Greek, Russian or Turkish.

1

Press **ANALOG MENU**, the menu will appear on the screen.

Press **◀ or ▶** to select **⚙️ (SETUP)** menu.

2

Press **▲ or ▼** to select **LANGUAGE**, then press **ENTER**.
 Press **◀ or ▶** to select the desired language, then press **ENTER**.

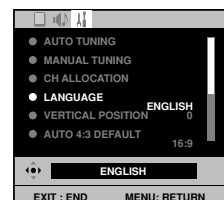

3

Press **EXIT** to return to the normal screen.

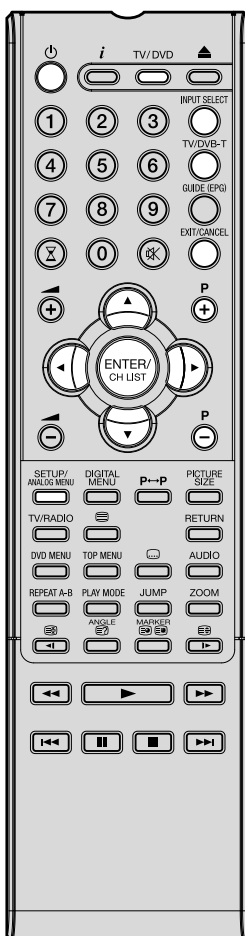

Auto setup

1 Switching on

Press **⏻ (STANDBY)** on the top side of the unit.
The Auto Installation menu will appear first.

2 Select language

Press **▲** or **▼** to select LANGUAGE, then press **ENTER**.
Press **◀** or **▶** to select the desired language, then press **ENTER**.

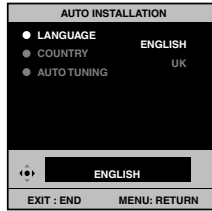

3 Select country

Press **▲** or **▼** to select COUNTRY, then press **ENTER**.
Press **◀** or **▶** to select your country, then press **ENTER**.

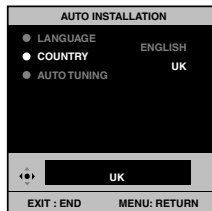

4 Start tuning

Press **▲** or **▼** to select AUTO TUNING, then press **ENTER**.

The confirmation message will be displayed.
Press **ENTER** to start automatic tuning.

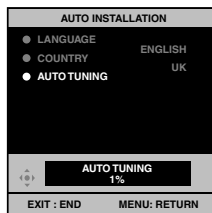

(ANALOGUE)

Your TV will now tune in all available channels.

Your TV will tune the analogue channels first, then tune the digital channels.

Note:

- Please be patient - the Auto Tuning process can take several minutes to complete.

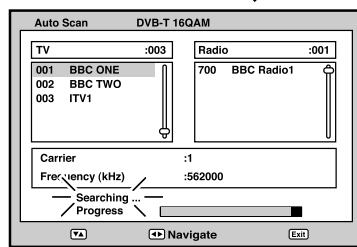

(DIGITAL)

When the programme on the screen stops changing and the sound comes on, the search process is complete.

Note:

- To cancel the Auto Tuning, press **ANALOG MENU** during the process.
- If the received signal for some channels is too weak, the automatic tuning system may not pick them up - in this case you may need to use manual tuning (see page 13).

Your television has an Automatic Tuning System which makes tuning in your television easy. This Automatic Tuning System scans the entire reception range in your area and automatically stores all available analog and digital (DVB) channels of suitable signal strength in the correct order e.g. BBC1 will tune into channel 1, BBC2 will tune into channel 2, etc.

THE AUTOMATIC TUNING PROCESS WILL ONLY START BY ITSELF THE FIRST TIME YOU SWITCH THE SET ON. TO RESTART AUTO TUNING, SEE PAGE 12 FOR ANALOGUE CHANNELS, AND PAGE 20 FOR DIGITAL CHANNELS.

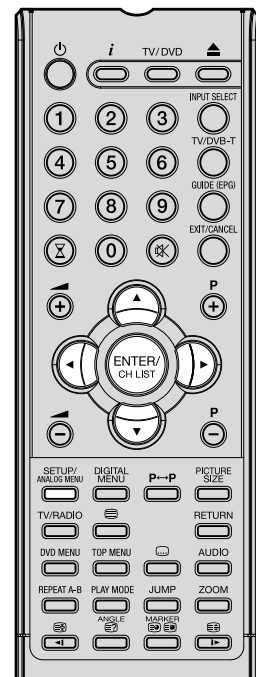

Auto tuning/Changing the order of stored channels

If you need to restart the automatic tuning process for analogue channels, use the following procedure.

This TV has 18 different countries for menu set up which can be selected through the On-Screen Display: UK, Germany, France, Spain, Italy, Belgium, Netherlands, Switzerland, Austria, Portugal, Finland, Poland, Czech Republic, Hungary, Slovenia, Greece, Russia, Turkey and Other.

Note:

- To restart digital auto tuning, see page 20.
- When the COUNTRY is set to UK, the automatic tuning will search for UHF broadcasts only.
- When allocating your channels, we recommend that you start with CH 1, continuing with the other channels afterwards.

SETUP menu

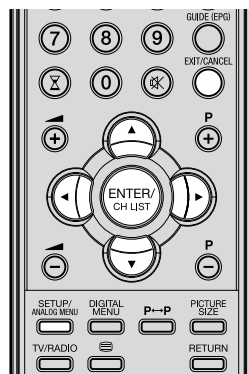
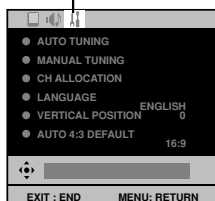

Preparation

Please ensure that all the connections have been made correctly (see page 3). If you need to restart the automatic tuning process, use the following procedure.

Auto tuning

1

Press **ANALOG MENU**, the menu will appear on the screen.

Press ◀ or ▶ to select (SETUP) menu.

Press ▲ or ▼ to select **AUTO TUNING**, then press **ENTER**.



2

Press ▲ or ▼ to select **COUNTRY**, then press **ENTER**.

Press ◀ or ▶ to select your country, then press **ENTER**.



3

Press ▲ or ▼ to select **START**, then press **ENTER**.

The automatic tuning will search for available broadcasts and should store the channels in the correct order. During the search the sound is muted. When all programmes have been stored, the normal TV screen will appear.

Changing the order of stored channels

The Automatic station presetting stores the stations found in a specific order. This will normally be the correct order (e.g. BBC1 on CH 1 etc.), however if it is necessary the order can be changed.

1

Press **ANALOG MENU**, the menu will appear on the screen.

Press ◀ or ▶ to select (SETUP) menu.

Press ▲ or ▼ to select **CH ALLOCATION**, then press **ENTER**.

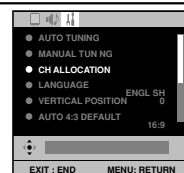

2

Press ▲ or ▼ to select desired option, then press **ENTER**.

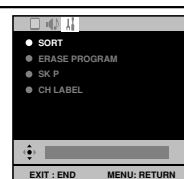

Description about the each setting option:

SORT: Press ▲ or ▼ to select the channel that you want to move, then press **ENTER**.

Press ▲ or ▼ to select the position that you want to move the channel to, then press **ENTER**.

ERASE PROGRAM: Press ▲ or ▼ to select the channel that you want to erase, then press **ENTER**.

SKIP: Press ▲ or ▼ to select the channel that you want to skip, then press **ENTER**. * mark will appear.

CH LABEL: Press ▲ or ▼ to select channel that you want to rename, then press **ENTER**. Press ▲ or ▼ to select character, then press ◀ or ▶. The cursor will move to the next position. Press **ENTER** to set the channel label.

3

After setting the each option, press **EXIT** to return to the normal screen.

Manual tuning

Example:

Preset BBC 2 in program position 2.

Preparation

Select program position 2.

1

Press **ANALOG MENU**, the menu will appear on the screen.

Press ◀ or ▶ to select  (SETUP) menu.

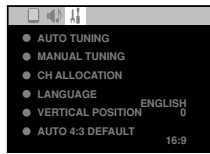

2

Press ▲ or ▼ to select **MANUAL TUNING**, then press **ENTER**.

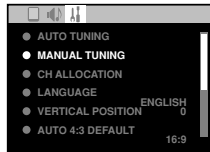

3

Press ▲ or ▼ to select **COLOUR SYSTEM**, then press **ENTER**.

Press ◀ or ▶ to select **AUTO**, **PAL** or **SECAM** then press **ENTER**.

Please note that **PAL** should be selected for use in UK.

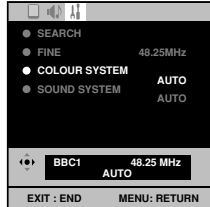

4

Press ▲ or ▼ to select **SOUND SYSTEM**, then press **ENTER**.

Press ◀ or ▶ to select **AUTO**, **B/G**, **I**, **D/K** or **L/L'**, then press **ENTER**.

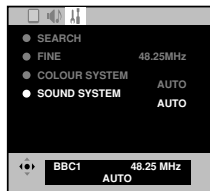

5

Press ▲ or ▼ to select **SEARCH**, then press **ENTER**.

Press ◀ or ▶. The auto search begins. It will stop at each station that has a good enough reception. Press ◀ or ▶ again until you receive a clear **BBC2** picture, then press **ENTER**.

- If you want to stop the search manually, press **ENTER** while the frequencies is counting up.

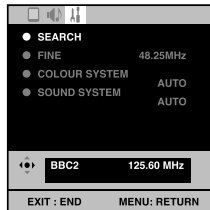

6

The auto search should find the best reception automatically, so fine tuning is not normally necessary. However if you want you can fine tune the reception manually...

Press ▲ or ▼ to select **FINE**, then press **ENTER**.

Press ◀ or ▶ to tune the receivable frequencies depending on TV norm, installation site, and range, then press **ENTER**.

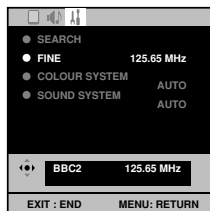

7

Repeat steps above to preset other TV stations.

8

Press **EXIT** to return to the normal screen.

Usually the Auto Tuning stores all available stations in the reception area. If some stations have poor reception, they may not be stored - however, you can store these manually if you wish.

SETUP menu

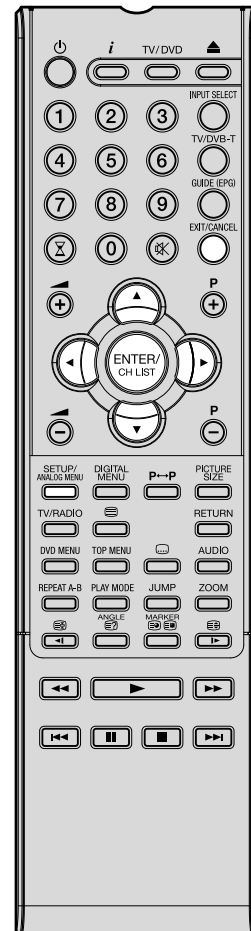
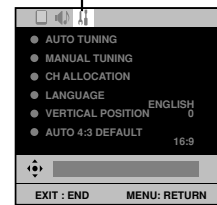

Basic TV functions

Note:

- If the built-in tuner does not receive any signal (e.g. if no aerial is connected or if the broadcast transmission stops) during TV operation, this unit will switch to standby after approx. 15 minutes.

Channel Selection

With the **10 Number Buttons**.

Example:

- No. 2: Press **0** and within 2 seconds, press **2**. The station stored in the CH2 position will appear.
- No. 29: Press **2** and within 2 seconds, press **9**. The station stored in the CH29 position will appear.

With the **P +** or **P -** buttons.

Press **P +** or **P -** to change the program number up or down. Each change will take approx. 2 seconds.

- In DTV mode

Min. numbered Digital CH \longleftrightarrow Max. numbered Digital CH

- Other than DTV mode

\rightarrow Min. numbered Analogue CH \longleftrightarrow Max. numbered Analogue CH \leftarrow
 \rightarrow DVD \longleftrightarrow PC \longleftrightarrow HDMI \longleftrightarrow COMPONENT \longleftrightarrow AV2 \longleftrightarrow AV1 \leftarrow

With the **CH LIST** button.

Press **CH LIST** to display channel list. Press \blacktriangle or \blacktriangledown to select the desired program, then press **CH LIST** to display the selected program.

If the auto search only stored 5 stations, only these 5 will appear. Concealed channels will not appear (see page 12).

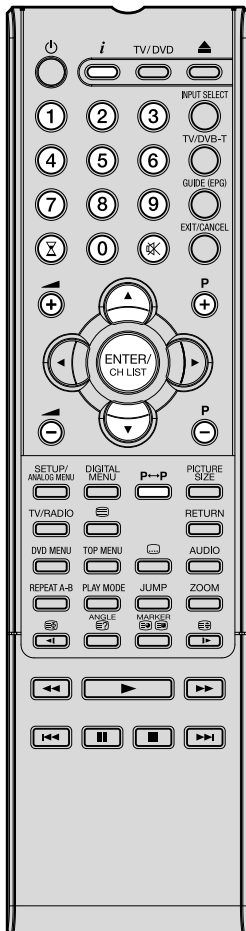

Quick View

P \leftrightarrow P button allows you to go back to the last selected channel or input source.

Volume adjusting

Press \blacktriangle + or \blacktriangledown - to adjust the volume. The volume level indicator disappears after 4 seconds.

MUTE

Press \times . The sound will be cut off. MUTE will display on the screen for approx. 4 seconds. The muting can be released by pressing \times again or \blacktriangle + or \blacktriangledown -.

DISPLAY

In the analogue TV mode: Press **i**. Channel number and picture size setting will appear for approx. 4 seconds.

In the digital TV mode: Press **i**. The program information will appear (see 'Channel banner' on page 27).

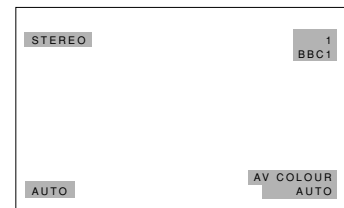

SLEEP TIMER

Press \times . SLEEP and the number of minutes until the set is due to shut - off will appear. Each time you press \times the SLEEP time will decrease in 10 minute intervals.

When the displayed time runs out, the unit will switch to standby. The display will disappear after approx. 4 seconds.



To cancel the sleep timer:

Press \times repeatedly until '0' appears.

Teletext

Teletext is sent page by page. This unit is able to automatically store up to 256 pages. Storage lasts until all pages have been received. The pages can only be accessed when they have been stored. This can take a moment.

Fastext/TOPtext

The Fastext/TOPtext is teletext with a special directory.

On the lower part of the screen there are four different coloured fields (red, green, yellow and blue). These fields lead directly to the pages shown within. The **Four coloured buttons** on the remote control correspond to the coloured fields. Press the appropriate coloured button in order to go to the page represented by that particular colour field.

Switch on / off Teletext

Teletext is not transmitted by all channels.

Select a channel that shows teletext.

Press . You will now see a teletext page (as long as it is available).

Press  again to display the Teletext and normal TV picture at the same time on the screen.

Each time you press , the screen switches as shown right.

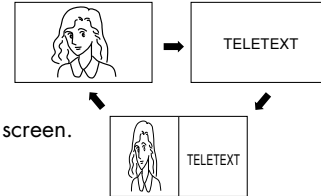

Note:

You cannot select any other channels as long as teletext is switched on. Switch teletext off when you want to switch over to another channel.



Select Page

Press **P +** or **P -** until the desired page appears. Or ... enter the requested page number by using the **10 Number Buttons**.

And if you mistype something, just enter the complete 3-digit wrong page number then enter the desired number again. Or ... press one of the coloured teletext buttons so that a page from Fastext/TOPtext is shown.

Hold Pages

Some pages are divided up into subpages by the channel.

Subpages are automatically shown in turn, as they are transmitted. In order to hold the page, press . Press  again in order to display the next subpage.



Directly Select Subpages

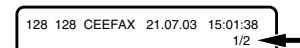

You can directly select the subpages if required.



Example:

Page 128 from Teletext may comprise 2 subpages. In the right upper corner you will, for example, see 1/2. That means that page one of 2 subpages is being shown at the moment.

Press   in order to select subpage 2. Four dashes (---) are shown. Enter '0002'. It can take a minute before subpage 0002 appears.

Press   again in order to switch off the subpage feature. You can only select other teletext pages when the subpage feature is switched off.

Enlargement

In order to enlarge the display, press .

Either the upper or lower half of the screen is enlarged.

Each time you press  you switch between the display of the upper or lower half of the screen or the full picture.

Answering Quiz Questions

Some pages contain quiz questions with concealed answers.

Press  in order to show the answers.

Index page (Page 100)

Press **ENTER** in order to show page 100 (this is normally the Index page).

Adjusting the NICAM stereo sound

The built-in tuner can receive and distinguish NICAM Stereo broadcasts automatically, provided the NICAM setting in the menu is set to 'AUTO'.

Note:

- Sometimes if reception is poor, the NICAM stereo sound may not be received correctly. In case of 2 channel sound reception, you can select the desired sound with **AUDIO**.

AUDIO menu

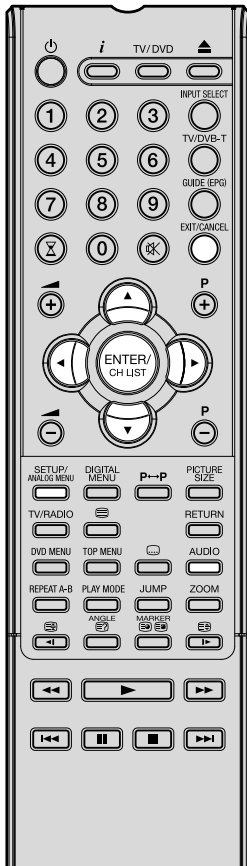

NICAM stereo sound reception:

1

Press **ANALOG MENU**, the menu will appear on the screen.

Press ◀ or ▶ to select (AUDIO) menu.

Press ▲ or ▼ to select NICAM, then press **ENTER**.

Press ◀ or ▶ to select AUTO or OFF.

Select OFF if you want to revert to standard mono FM audio reception.

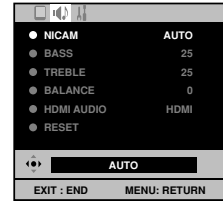

2

Press **EXIT** to return to the normal screen.

When NICAM reception is available, one of the following indications will be displayed.

'NICAM ST' illuminates for approx. 4 seconds when a NICAM STEREO broadcast signal is received.



'NICAM M1' illuminates for approx. 4 seconds when a NICAM MONO A broadcast signal is received.



'NICAM M1/M2' illuminates for approx. 4 seconds when a NICAM MONO A and MONO B broadcast signal is received.



This will be displayed for approx. 4 seconds when 'NICAM OFF' is selected in the menu screen.



Stereo reception

'STEREO' illuminates for approx. 4 seconds when a STEREO broadcast signal is received.



Adjusting the Nicam stereo sound

Pressing **AUDIO** alternates between the two different audio channels (when applicable).

NICAM 2-channel sound reception

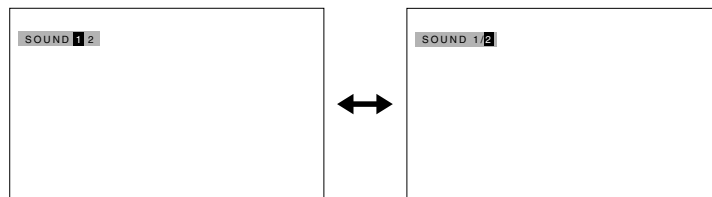

Picture format

Pressing **PICTURE SIZE** repeatedly scrolls through the following options.

Manual format setting

4:3

It shows a 4:3 picture in original size with black bands on left and right side.

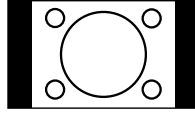

FULL SCREEN:

Stretches the left and right hand sides of a 4:3 picture horizontally to fill the screen, while leaving the centre of the picture unstretched.

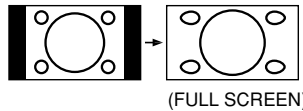

Note:

- In this mode the picture is geometrically distorted on the left and the right sides of the screen.

16:9

This mode is used with 16:9 signals from the Digital tuner, a DVD player or other external source. This uniformly stretches a 4:3 image horizontally to fill the screen (For example, a 16:9 image is often stored 'anamorphically' on a DVD, where the 16:9 image is stored as a horizontally compressed 4:3 image - this mode restores the image to its correct 16:9 proportions).

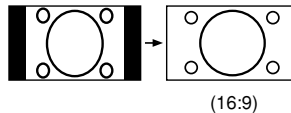

CINEMA:

This mode is used to zoom-in on (expand) 4:3 'letterbox' format pictures (with black bars at the top and bottom) so that they fill more of the screen.

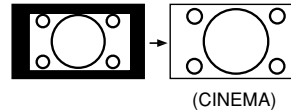

Note:

- In the CINEMA mode, part of the picture may be slightly cut off due to the expansion. However, it is possible to scroll the picture up or down to view the top or bottom part of the picture (see page 18).
- If you operate OSD functions such as the EPG or Digital Menu whilst in the CINEMA mode, the screen will temporarily change to the FULL SCREEN mode.

14:9:

This enlarges a 4:3 picture to the 14:9 format.

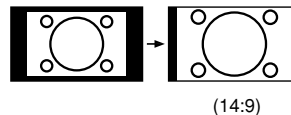

AUTO:

Automatically selects the aspect ratio (see note to the right).



Note: When the PICTURE SIZE is set to AUTO, the aspect ratio will automatically change according to the Wide Screen Switching (WSS) signal, if it is available. This may be either transmitted by the broadcasting TV channel, or via a recording from a VCR etc. Any WSS signal received will only be effective in the AUTO mode - however, some DVD players / Digital Decoders etc. will automatically switch the aspect ratio via the SCART input (Pin 8 switching), even if AUTO is not selected. In any case if you want to change to a different aspect ratio to the one selected automatically, you can change it by pressing PICTURE SIZE.

In PC mode, the PICTURE SIZE feature is available only for 16:9 or 4:3 format. (In "WXGA INPUT" mode, the PICTURE SIZE feature is not available.)

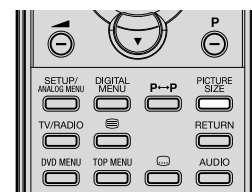
In HDMI or COMPONENT mode of scanning rate: 720p and 1080i, the PICTURE SIZE feature is available only for AUTO and CINEMA format.



Other useful functions

Icon	Selected Items		Setup hint
	PICTURE PREFERENCE	SPORTS	Bright and dynamic picture (factory-set)
		STANDARD	Standard picture quality (factory-set)
		MOVIE	Movie-like picture setting (factory-set)
		MEMORY	Your personal preferences
	BRIGHTNESS / CONTRAST / COLOUR / TINT (NTSC) / SHARPNESS		You can adjust the picture to your preference. PLEASE NOTE: The "TINT(NTSC)" function can only be selected in an NTSC 3.58MHz or NTSC 4.43MHz signal is input through one of the AV sockets, and NTSC or AUTO has been selected for the AV COLOUR option.
	COLOUR TEMPERATURE		Bluish (COOL) / Neutral (MEDIUM) / Reddish (WARM)
	BLUE BACK	ON / OFF	You can set the TV to automatically change to a blue screen and mute the sound if the signal is weak or absent.
BACKLIGHT		You can use the Back light feature to adjust the screen brightness for improved picture clarity.	
RESET		Select "RESET" to reset PICTURE PREFERENCE, BRIGHTNESS, CONTRAST, COLOUR, TINT (NTSC) / SHARPNESS, COLOUR TEMPERATURE and BACKLIGHT to the factory preset values.	
	NICAM		See page 16.
	BASS / TREBLE / BALANCE		You can adjust the sound quality to your preference.
	HDMI AUDIO		See page 9.
	RESET		Select "RESET" to reset BASS, TREBLE and BALANCE to the factory preset values.
	AUTO TUNING		See page 12.
	MANUAL TUNING		See page 13.
	CH ALLOCATION		See page 12.
	LANGUAGE		See page 10.
	VERTICAL POSITION		When the CINEMA mode is selected (see page 17), you can adjust the vertical picture position. Press ◀ or ▶ to adjust the vertical position of the picture by up to +10 and downwards by up to -10.
	AUTO 4:3 DEFAULT ^{*1}	4:3 / 16:9	This option selects the default way that a 4:3 signal is shown - either as normal "4:3" or expanded in the "16:9" mode, according to your preferences.
	AV1 OUTPUT	TV/MONITOR	See page 6.
	AV COLOUR ^{*2}		The AV Colour setting only applies when viewing devices connected to the AV inputs.
	REC SCREEN STATUS	ON / OFF	This function is used in conjunction with the Timer function that is included as STATUS part of the Digital EPG. It determines whether the TV screen switches on or not when a programmed Timer setting begins - see page 31 for further details.

Note:

^{*1} AUTO 4:3 DEFAULT is available only for AUTO picture size setting.

^{*1} In COMPONENT mode, AUTO 4:3 DEFAULT is available only for 480i/576i mode.

^{*2} PAL is the colour system used in Germany. NTSC 3.58 is used in the USA, PAL 60 used in Germany handled video recorders, which play NTSC video tape recording.

Guide to using the Digital Menu System

Preparation

Press **TV/DVD** to select TV mode and press **TV/DVB-T** to select the digital TV mode.

or

Press **INPUT SELECT** and press **▲** or **▼** to select DTV, then press **ENTER**.

1

Press **DIGITAL MENU** to display the Main menu.
Press **◀** or **▶** to select desired options.
(Example: selecting the Language Setup option.)

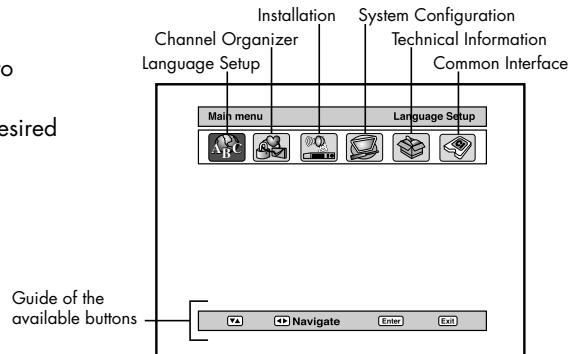

2

Press **ENTER**.
The selected menu will appear.

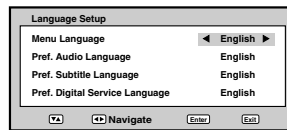

Some of the options have a sub menu.
Press **▲** or **▼** to select desired sub menu, then press **ENTER**.

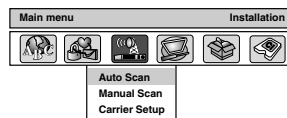

(Example: sub menu in the Installation option.)

3

When you have finished making adjustments, press **EXIT** to return to the normal screen.

Note:

- In analogue TV mode, **DIGITAL MENU** will not work. Please press **TV/DVB-T** to select digital TV mode to display the digital menu. However, it is possible to use the **ANALOG MENU** in the digital TV mode. The analogue menu includes some general settings for this TV that apply to both modes, and it will be displayed over the digital TV screen.

When the set is in the digital mode, you can access the main menu by pressing **DIGITAL MENU** on the remote control.

This main menu contains several options,

- Language Setup
- Channel Organizer
- Installation
- System Configuration
- Technical Information
- Common Interface

The main menu is the gateway for all the other 'sub' menus.

You can navigate between the different options in the main menu by pressing **◀** or **▶**.

The **DIGITAL MENU** key will also function like an 'EXIT' key, i.e. when any menu is active, pressing the **DIGITAL MENU** key will return to the previous stage.



Language Setup/Auto Scan

DIGITAL MENU allows you to make your own choice of language which you wish to have. From the list of languages you can select the preferred,

- Menu Language
- Pref. Audio Language
- Pref. Subtitle Language
- Pref. Digital Service Language

Menu languages supported are English, French, German, Italian, Spanish, Russian, Portuguese, Dutch, Polish, Swedish, Turkish, Finnish and Greek. (Welsh and Gaelic are available only for Digital Service Language.)

Note:

- All the channels will be deleted before the scanning process begins.
- You can cancel the scan process at any time by pressing **EXIT**. The carriers and the services stored before **EXIT** is pressed will be stored.



Language Setup

1

Press **DIGITAL MENU**, the menu will appear on the screen.

Press ◀ or ▶ to select Language Setup option, then press **ENTER**.



2

Language Setup menu will appear.

Press ▲ or ▼ to select the item you want to change.

Press ◀ or ▶ to select desired language.



3

When all changes are decided, press **EXIT** to return to the normal screen.

Auto Scan

Preparation

- Please ensure that all the connections have been made correctly (see page 3).

1

Press **DIGITAL MENU**, the menu will appear on the screen.

Press ◀ or ▶ to select Installation option.

Press ▲ or ▼ to select 'Auto Scan' from the sub menu tab, then press **ENTER**.

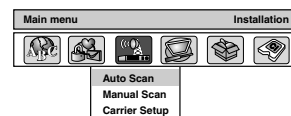

2

The confirmation banner will be displayed.

Press ◀ or ▶ to select 'Yes' or 'No', then press **ENTER**.

3

The Auto Scan process will now begin.

The scanning process will be displayed in the progress bar.

When the search has been completed 'Scan completed' message will be displayed.

And the Auto Scan menu will exit automatically.

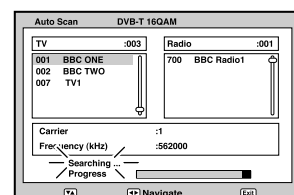

Manual Scan/Carrier Setup

Manual Scan

1

Press **DIGITAL MENU**, the menu will appear on the screen.

Press ◀ or ▶ to select Installation option.

Press ▲ or ▼ to select 'Manual Scan' from the sub menu tab, then press **ENTER**.

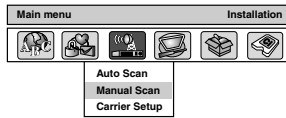

2

You can choose the carrier number from the Channel list by using ◀ or ▶ and the corresponding frequency set for the carrier will be set for tuning.

Otherwise you can also directly enter the frequency value to start the tuning.

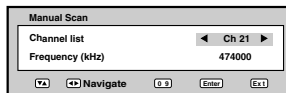

3

After setting the carrier, press **ENTER** to start the scanning. During the scan process, the list of services (TV/Radio) collected for the carrier will be listed.

On completion, 'Scan completed' message will be shown.

4

Then the confirmation banner will be displayed.

Press ◀ or ▶ to select 'Yes' or 'No', then press **ENTER**.

5

Press **EXIT** to return to the normal screen.

Carrier Setup

1

Press **DIGITAL MENU**, the menu will appear on the screen.

Press ◀ or ▶ to select Installation option.

Press ▲ or ▼ to select 'Carrier Setup' from the sub menu tab, then press **ENTER**.

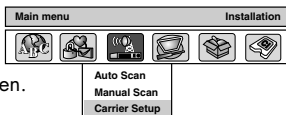

2

All the carriers are listed with their frequency and service information - the user can scroll through the carrier list and select each one individually to Rename, Delete or Rescan.

3

Rename:

Select carrier, then press **Red** button. The alphanumeric keypad will appear. You can rename a service as per your preference.

Delete:

Select carrier, then press **Green** button. The check mark (✓) will be displayed for selected carrier. Then press **ENTER**. The confirmation banner will be displayed.

Press ◀ or ▶ to select 'Yes' or 'No', then press **ENTER**. If the option 'Yes' is selected then all the marked carriers will be deleted from the list.

Rescan:

Rescan allows to tune the already tuned carrier, to collect any new programmes that are currently available in the stream. Press **Blue** button, to rescan the current selected carrier.

With the Manual Scan option, you can tune one carrier at a time, by entering the carrier parameters manually.

The Carrier setup option menu lists all the carriers (multiplexes) that are currently available and allows you to rename, Delete or Rescan carriers individually. **WE STRONGLY SUGGEST YOU NEVER DELETE ANY OF THE CARRIER INFORMATION UNLESS INSTRUCTED TO DO SO.**

Note:

- If on the 'AUTO INSTALLATION (COUNTRY)' screen 'FINLAND' is selected, "Frequency (kHz)" cannot be used.

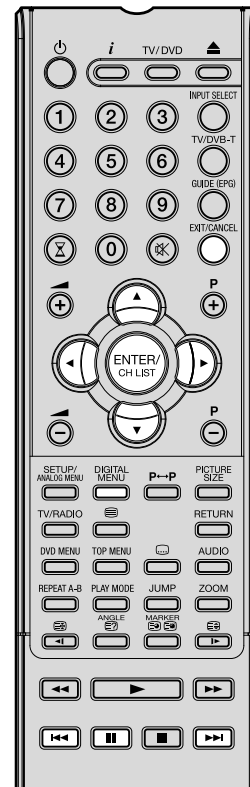

Channel Organizer

The Channel Organizer feature provides options to organise the channels. The following options are supported: Favourite, Lock, Skip, Go To, Delete, Rename, Move, Move to, View.

Note:

- While in TV mode, only TV programmes will be displayed and only radio programmes will be displayed while in radio mode.
- Channel / Service names can only be displayed up to 10 characters - if the name is longer than this, it will be abbreviated.
- If you select 'UK' on the 'AUTO INSTALLATION (see page 11)' or the 'AUTO TUNING (see page 12)', 'Move to' cannot be used.

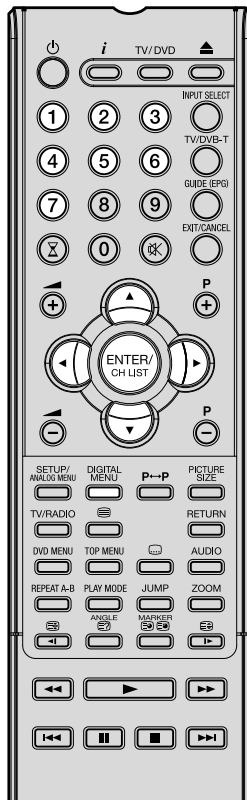

1

Press **DIGITAL MENU**, the menu will appear on the screen.

Press ◀ or ▶ to select Channel Organizer option, then press **ENTER**.



2

The Channel Organizer menu will appear. The available programmes will be listed, depending on the current mode. The selected programme will be highlighted.

To toggle within the service list, press ▲ or ▼.

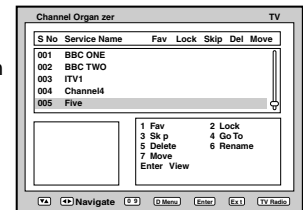

3

By pressing the corresponding **Number Button (1-7)** or the **ENTER** key, you can activate the following functions from this menu for each channel: Favourite, Lock, Skip, Go To, Delete, Rename, Move and View. (You can de-activate each of these functions by pressing the same number again.)

Indications:

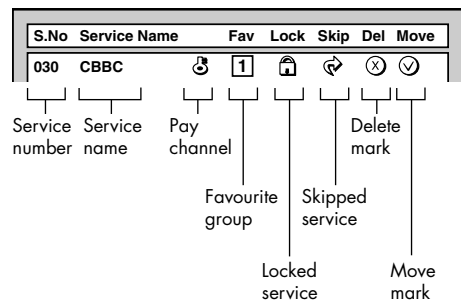

Channel Organizer

Fav *1	None	Assign services to four different favourite groups.
	Fav 1	1 Press ▲/▼ to select the desired service.
	Fav 2	2 Press 1 on the remote control. A selection box displays.
	Fav 3	3 Press ▲/▼ to register the selected service to any of the four favourite groups (None, Fav1 ... Fav4) and then press ENTER . An icon displays indicating the favourite status.
	Fav 4	4 Press DIGITAL MENU . 5 Now you can easily select your favourite service from the Channel List (See page 26).
Lock		When the service is locked, you must enter your PIN whenever you tune to the service. 1 Press ▲/▼ to select the desired service. 2 Press 2 on the remote control. If you already set the PIN, enter it here. If not, enter the factory preset PIN "0000". An icon displays indicating the service is locked. • Pressing 2 will turn the lock icon on and off. (PIN entry is required.) 3 Press DIGITAL MENU .
Skip		Services that are set to skip will not be picked up when pressing P +/- . 1 Press ▲/▼ to select the desired service. 2 Press 3 on the remote control. An icon displays indicating the service to be skipped. • Pressing 3 will turn the skip icon on and off. 3 Press DIGITAL MENU . • To view services that are set to be skipped, use 0-9 or select from the Channel List.
Go To		Use this function to jump to the specific service in one step. This is useful when there are many services displayed on screen to scroll through. 1 Press 4 on the remote control. Now you can change the service number on the left side of the screen. 2 Enter the number using 0-9 , and then press ENTER . The highlight moves to the selected service.
Delete		Delete the selected service(s) from the memory. 1 Press ▲/▼ to select the desired service. 2 Press 5 on the remote control. An icon displays indicating the service to be deleted. • Pressing 5 will turn the delete icon on and off. 3 Press DIGITAL MENU . A confirmation message displays. 4 Press ◀/▶ to select "Yes", and then press ENTER .
Rename		Change individual service names. 1 Press ▲/▼ to select the desired service. 2 Press 6 on the remote control. A character set screen displays. 3 Enter new name for the service. 4 Press DIGITAL MENU . A confirmation message displays. 5 Press ◀/▶ to select "Yes", and then press ENTER .
Move		Sort the order of the selected service by moving the service position. 1 Press ▲/▼ to select the desired service. 2 Press 7 on the remote control. An icon displays indicating the service to be moved. • Pressing 7 will turn the move icon on and off. 3 Move the selected service to the desired position using ▲/▼, and then press ENTER to register the change.
Move To *2		Sort the order of the selected service by modifying the service number. 1 Press ▲/▼ to select the desired service. 2 Press 8 on the remote control. Now you can change the service number on the left side of the screen. 3 Enter the number using 0-9 , and then press ENTER . The service moves to the new position.
View		Change to the service shown in the picture window. 1 Press ▲/▼ to select the desired service. 2 Press ENTER on the remote control. The image shown in the picture window changes. 3 Press EXIT to exit the Channel Organizer screen to view the image in full screen

Note:

*1 You cannot register the same service to two different favourite groups.

*2 If on the "FIRST INSTALLATION (COUNTRY)" screen "UK" is selected, "Move To" cannot be used in U.K.

Display Setup/Password Setup (Parental lock)

Display Setup feature allows you to change the Display Setup settings as per your preference. In this menu the following options are available.

Password Setup feature allows you to have a parental control of the service viewing as per your preference. Once a service is protected with a password, it cannot be viewed unless the correct password is provided.

Note:

- There are 15 age-based ratings, ranging from '4' (years old) to '18' (years old) and 'None'. Eg. If the Parental Lock is set to '8' (years old), only the services which have the parental rating of '8' (years old) or under will be viewable without entering the Password.
- You will be prompted to enter the password, when you set new parental rating. You can set the new parental rating only when you enter the password correctly, otherwise the old parental code will be retained.



Display Setup

1

Press **DIGITAL MENU**, the menu will appear on the screen. Press ◀ or ▶ to select System Configuration option. Press ▲ or ▼ to select 'Display Setup' from sub menu tab, then press **ENTER**.

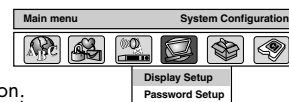

2

Display Setup menu will appear. Press ▲ or ▼ to select the item you want to change (see the left note for details of each setting). Then you can change each setting by pressing ◀ or ▶.

Banner timeout	1 Sec, 2 Secs... 7 Secs	Select how long the service banner information appears on screen.
Banner position	Top Bottom	Select whether the service banner information appears on top or bottom of the screen.
Display Transparency	None 10%, 20% ... 50%	Select the desired level of On-Screen Display transparency.

3

After all the changes are made, press **EXIT** to return to the normal screen.

Password Setup (Parental lock)

PLEASE NOTE THAT AT THE TIME OF WRITING, THIS AGE RESTRICTION SERVICE HAS NOT YET BEEN IMPLEMENTED FOR DVB SERVICES IN THE UK

1

Press **DIGITAL MENU**, the menu will appear on the screen. Press ◀ or ▶ to select System Configuration option. Press ▲ or ▼ to select 'Password Setup' from sub menu tab, then press **ENTER**.

2

'Enter Password' will appear. Press '0 0 0 0' using the **Number Buttons**. (This is the default password.)

3

Press ▲ or ▼ to select 'Parental Lock', then press ◀ or ▶ to select desired parental rating (see note). Then press **EXIT** to return to the normal screen.

4

You can also change the password using the next option.

Press ▲ or ▼ to select 'Change password'. Then enter your chosen new password (be sure to remember this password). After you have entered the new password for the first time, you need to enter the same password again for confirmation. The Information banner will then appear.

Press **EXIT** to return to the normal screen.

While toggling between channels, if a service which has a parental rating is selected then you will be asked to enter the correct password to view that channel. If the channel you are currently watching supports a parental rating then the rating will also be displayed in the Channel banner menu (see page 27).

Version/Software Upgrade/Common Interface

Version

1

Press **DIGITAL MENU**, the menu will appear on the screen.

Press ◀ or ▶ to select Technical Information option.

Press ▲ or ▼ to select 'Version' from the sub menu tab, then press **ENTER**.

Version information banner will appear.

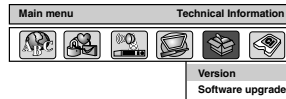

Software Upgrade

1

Turn to a BBC channel first!

Select Technical Information option (the 5th icon along at the top of the menu).

Select 'Software upgrade' from sub menu tab by pressing ▲ or ▼. Then press **ENTER**.

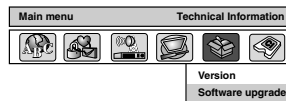

2

If a software upgrade is available from an Over-Air-Download (OAD) then the message 'S/W available, do you want to download?' will be displayed - you can then select 'Yes' or 'No' by pressing ◀ or ▶, then press **ENTER**.

3

If you select the option 'Yes' then the Software Upgrade process will be initiated. It will take about 20 minutes and after this process is complete, the TV will be rebooted automatically.

If you select the option 'No' you can continue to watch TV programmes as before.

Common Interface

1

Press **DIGITAL MENU**, the menu will appear on the screen. Press ◀ or ▶ to select Common Interface option, then press **ENTER**.



2

The CAM module name will be displayed. You have to press **ENTER** to view further information.

3

In the CI Menu, CAM specific information such as Module information, Smart card information Language and Software Download are shown.

Press ▲ or ▼ to select information, then press **ENTER** to see detail.

4

Press **EXIT** to return to the normal screen.

Note:

- If you remove the CAM module in the digital TV mode then 'CAM module has been removed' will be shown on the screen.
If you enter into the Common Interface menu when the CAM is not inserted then 'No CAM Found' will be displayed.

From the Technical Information option in the menu you can access the Version and Software upgrade menus.

Software Upgrade allows you to download the latest software available on the Engineering channel which is carried on Multiplex 1 (BBC).

Note:

- During the Software Updating process, do not turn off the unit. At this time you cannot use any of the buttons, apart from ⏻ (STANDBY).
- After the Software Updating process, the Digital Menu memory settings will be lost, so it is necessary to go through the setting up procedures again.



Channel list

The Channel list menu can also be referred to as the Quick Select Menu, as it allows you to view the list of services available in the database with a single click, instead of navigating through various menus.

1

Press **CH LIST** to display the Channel list menu.

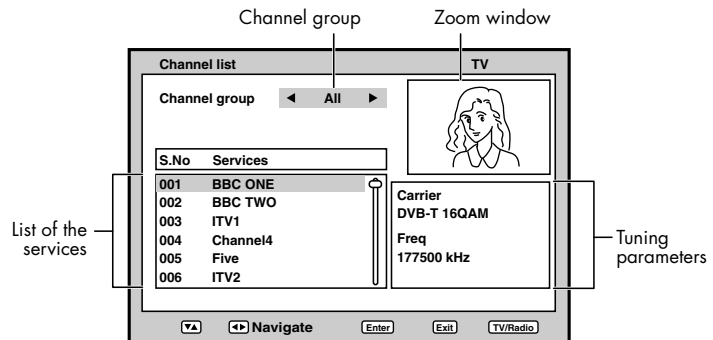

Menu description

In the case of TV channels, a small picture of the selected service will be shown in the preview window. For Radio channels, a still picture will be displayed in the Preview window. In the case of a service which has Teletext data only, 'No Video' or 'No Audio' will be displayed in the Preview window. The tuning parameters are displayed in the lower right part of the Menu screen.

2

Select the Channel group (Favourite):

Press ◀ or ▶ to select between Channel groups - you can toggle through All (complete channel list)/Fav1/Fav2/Fav3/Fav4 (see 'Fav' on page 23 for details on setting Favourites).

Select the Services:

List of the services present under the selected Channel group will be displayed in the left side of the menu.

Press ▲ or ▼ to toggle within the service list, then press **ENTER**.

Toggle between the list of TV and Radio services:

The **TV/RADIO** key is used to toggle between the TV and Radio mode. If you press **CH LIST** when you are in Radio mode then the channel list menu will display the list of Radio services. If you wish to view the list of TV services without exiting the current menu, **TV/RADIO** key should be pressed once.

Note:

- If any Channel group doesn't have any service at the time, 'No services' and 'No Information' will be displayed in the menu.
- Channel / Service names can only be displayed up to about 12 characters - if the name is longer than this, it will be abbreviated.

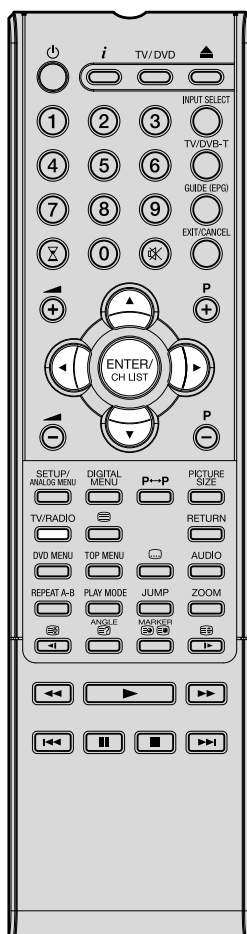

Channel banner

Preparation

When you change from one channel to another, the Channel banner will be displayed for the selected service. In the channel banner menu, information such as current date & time, channel name, etc. will be displayed.

1

While watching the service, press **i** to display the Channel banner at any time. It will disappear after the Banner timeout value (this can be adjusted to your preferred value, see page 24).

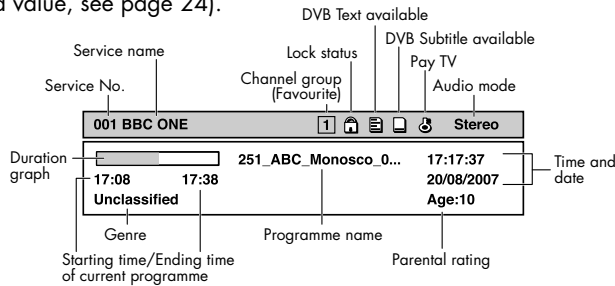

If the selected channel supports special features like, DVB Text, DVB Subtitle, Audio mode (Left, Right, Stereo), parental rating, etc. this information will be shown in the channel banner as above.

2

Press **i** again to display the Basic Service information. You can verify the signal strength and quality of the selected service here.

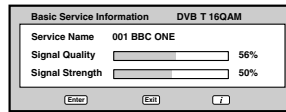

3

To remove the Channel banner immediately, press **i** again.

The Channel banner should be displayed for every channel change and also through direct numeric key input.

The Channel banner allows you to have a brief gist of the service details while toggling itself. The menu comprises of all the necessary details about that service.

Note:

- Subtitles are displayed on the channel banner. Some broadcasts may not provide this service.

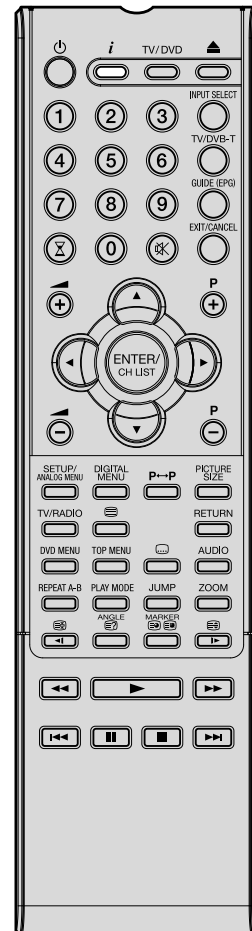

Multi audio/DVB-Subtitle

You can select your preferred Audio mode and DVB (digital TV) subtitle Language. The Multi audio menu will display the Audio mode and Language options available with the current broadcast.

DVB-Subtitle is a feature supported in DVB (Digital Video Broadcasting) applications in which the service shown can be accompanied by a text display on the screen in parallel with the corresponding audio service. The DVB-Subtitle feature can be enabled or disabled at anytime.

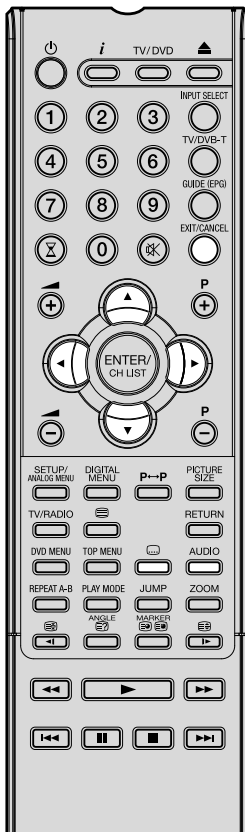

PLEASE NOTE THAT AT THE TIME OF WRITING, THE MULTI-LANGUAGE OPTIONS FOR DVB AUDIO AND SUBTITLES HAVE NOT YET BEEN IMPLEMENTED.

Multi audio

1

Press **AUDIO** to display the Multi audio menu. The Audio mode and Language code will be displayed if available.

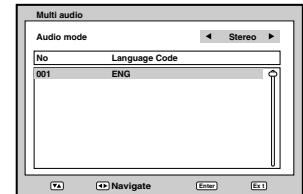

2

To select Audio mode, press ◀ or ▶. In general the below audio modes will be supported in a service. Left, Right, L + R and Stereo.

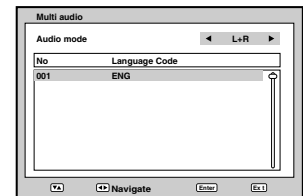

To select a Language code, press ▲ or ▼ to select code within Language Code List.

3

Press **EXIT**. Your selected audio preferences will be saved.

DVB-Subtitle

1

Press **[...]** to display the DVB-Subtitle menu when subtitles are available.

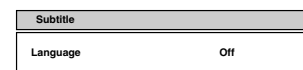

2

Press **[...]** repeatedly to select your desired subtitle language from the available languages.



3

To turn off the DVB-Subtitle, press **[...]** repeatedly until 'Off' appears in the Subtitle menu.

DVB Text

1

Select a channel which has DVB Text - i.e. One which has the Teletext icon (☰) is displayed in the Channel banner (see page 27).

2

Press ☰ - the DVB Text page for that channel should be displayed.
Each time you press ☰, the screen switches as shown below.

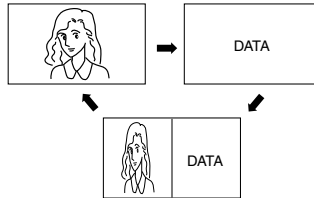

3

There are various links in the DVB Text screen. You can navigate the pages by pressing the buttons on the remote control as follows;

- If there are numbered links, press the corresponding one of the **Number Buttons**.
- If there are coloured links, press the corresponding one of the **four coloured buttons** (red / green / yellow / blue).
- If there is a movable cursor, press ▲/▼/◀/▶ to select your desired link, then press **ENTER**.

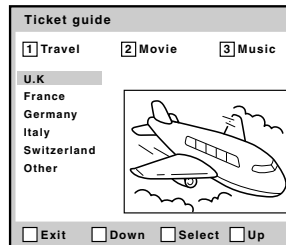

4

To see other DVB Text channels, press ☰ to exit current service, then select another channel which has a DVB Text service.

Note:

- If you enter the EPG or Digital Menu whilst using some DVB Text services, it may not return to the Teletext screen you were viewing before - in this case just press the ☰ button again and re-select the required page.

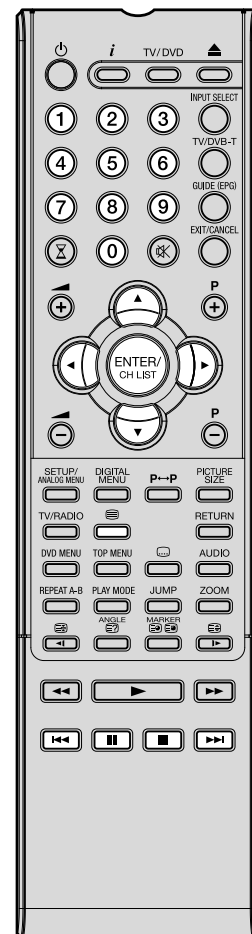

EPG (Electronic Program Guide)

The Guide menu shows the available programme listings for the next 8 days only, including today. However, the guide menu will show "No Event Name" for programmes which are more than 8 days ahead, or for programmes within the 8 days when no programme information is available.

1

Press **GUIDE** to display the Guide menu.

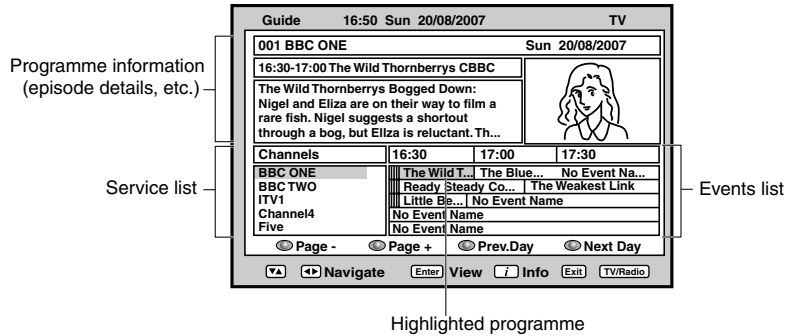

Service list :

Lists all the services that are currently available.

As you scroll through the service list by pressing **▲** or **▼**, the Event list will be refreshed accordingly, and you will see the programme information for the currently highlighted programme.

To scroll through the service list page by page, press **Red** or **Green** Key.

Events list :

List the events in a grid of rows and columns.

Each row shows the list of events that are available, for the corresponding service in the service list. Within each row, you can press **◀** or **▶** to navigate through the rest of the events.

You can easily move to the Previous day or Next day in the Events List by pressing **Yellow** or **Blue** key (the date of the programme information you are currently viewing is shown in the top right hand corner).

The full Event name along with the duration of the event will be displayed in the bar above. Event title will be displayed only if available otherwise 'No Description' message will be displayed.

2

From within the Guide menu, you can open the Description menu for the currently highlighted programme by pressing **i**.

The Guide/Description menu shows the extended event description of an event. You can scroll and view the complete event description of the event using **▲** or **▼**.

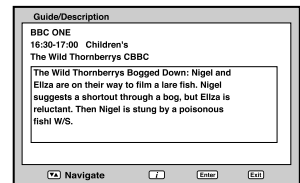

To return to the Guide menu, press **i**.

To clear the menu screen, press **EXIT**.

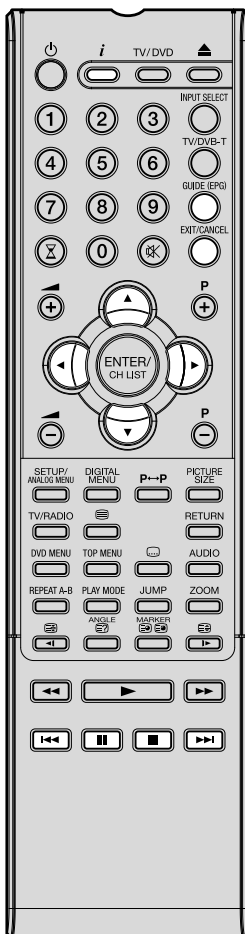

EPG Timer

1

Press **GUIDE** to display the Guide menu. Then press **▲/▼/◀/▶** to highlight the programme you want to set as an event timer, then press **ENTER**.

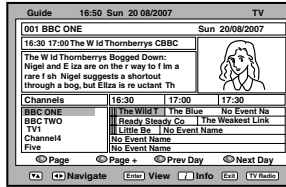

Note:

- If you select an event which has already started, the selected program will be displayed on the screen, as you cannot set the timer for a programme which has already started.
- To display the stored event timer, press **GUIDE** twice. The EPG Timer menu (see step 3 below) will appear. You can also delete or change the frequency (Once / Daily / Weekly) of the stored event timer (but please note that you cannot edit the time details that have been set from the EPG).

2

The confirmation banner will be displayed. Press **◀** or **▶** to select 'Yes' or 'No', then press **ENTER** (the selected option is shown in blue).

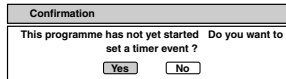

3

The EPG Timer menu will appear. Press the **Red** key to set the Timer mode for a selected event.

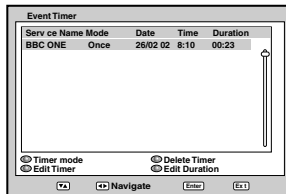

4

The Timer mode specifies the frequency of Timer wake-up which can be set as Once, Daily or Weekly. Press **ENTER** to save the selected Timer mode.

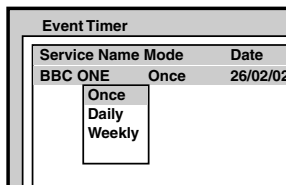

Note:

To delete an event timer, select the specified event, then press the **Green** key.

5

To return to the Guide menu, press **DIGITAL MENU**. To clear the menu screen, press **EXIT**.

Note:

- Press the **Yellow** key to change the start time of the event.
- Press the **Blue** key to change the time duration of the event.
- If the unit goes to standby mode (by pressing **⏻ (STANDBY)** on the unit or **⏻ (STANDBY)** on the remote control) after the EPG Timer has been set.

You can choose whether or not the screen switches on when the event timer begins - please see page 18 (Rec screen status (LCD Power on/off)). This is so that if you are using the timer to make a recording to your VCR or other device, the TV screen will not switch on unless you want it to.

If you try to switch to another channel while an event timer is in progress, the following message will appear: **'WARNING: CHANGING THE CHANNEL WILL INTERRUPT YOUR EVENT TIMER. ARE YOU SURE YOU WANT TO PROCEED? YES/NO'**. Select **YES** or **NO** according to your wishes.

Note:

- A maximum of eight Timers can be programmed.
- If the EPG Timer starts when it is already switched on, it will start at the exact time that is set. If it starts from the standby mode, it will begin 20 seconds in advance of the stated time.
- You cannot hasten the start time from the original start time of the Event.
- You cannot set with the same date and time of another Event.
- The programme set as event timer will be highlighted in the Guide menu.

Disc

DVD discs must be Region 2 or Region ALL type to play on this unit. The loaded Disc (DVD and Audio-CD) will be recognized automatically. The suitable disc formats are: DVD-Video, DVD-R/-RW (Video format only), Audio CD, CD-R/CD-RW, Video CD and SVCD.

Some CD-R/RW discs may be incompatible.

- This unit can play an 8cm disc. Please do not use a disc adapter. It may cause trouble.
- Please do not insert any disc of an irregular shape into the unit, as it may interfere with the function of the unit. You may not be able to remove it.
- Please do not use after market accessories, such as a ring protector, as this may cause trouble with the operation of the unit.

Do not play DVD-ROM, DVD-Audio, CD-G or Photo CD to prevent accidental erasure of prerecorded material.

Title

When two or more movies are recorded on a disc, the disc is divided into two or more sections. Each section is called a "TITLE".

Chapter

The titles can be subdivided into many sections. Each section is called a "CHAPTER".

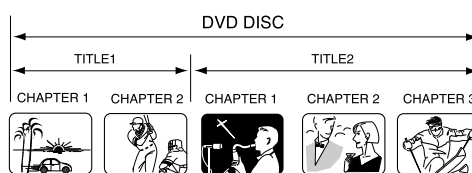

Track

An Audio CD can contain several items. These are assigned to tracks.

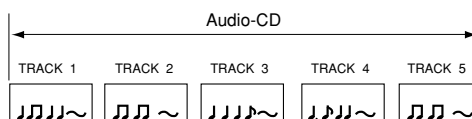

Removing Disc from Case

Be sure to hold the edge of disc. Do not touch the surface of the disc.

Pick up the disc gently from the case.

- Do not scratch the disc.
- Do not get dirt on the surface of the disc.
- Do not stick a label or adhesive tape on the disc.
- Do not drop or bend the disc.

Storing Disc

- Store the disc in the case to avoid risk of scratches, dirt or damage.
- Do not leave disc exposed to direct sunlight or in hot or humid places.

Cleaning Disc

Wipe the disc with a clean, dry cloth from center to edge.

- Do not wipe in circular direction.
- Do not use liquid or aerosol cleaners.

On Video CDs

This unit supports Video CDs equipped with the PBC (Version 2.0) function. (PBC is the abbreviation of Playback Control.) You can enjoy two playback variations depending on types of discs.

- Video CD not equipped with PBC function (Version 1.1) Sound and movie can be played on this DVD/VCR in the same way as an audio CD.
- Video CD equipped with PBC function (Version 2.0) In addition to operation of a Video CD not equipped with the PBC function, you can enjoy playback of interactive software with search function by using the menu displayed on the TV screen (Menu Playback). Some of the functions described in this owner's manual may not work with some discs.

To turn off the PBC

1. Press **PLAY MODE** in the Stop mode.
2. Press **▲/▼** to select "Mode", then press **ENTER** repeatedly until "off" appears.
3. Press **PLAY MODE** again to clear the screen.

To turn on the PBC

Follow the above step 1~2, then press **ENTER** repeatedly until "PBC" appear.

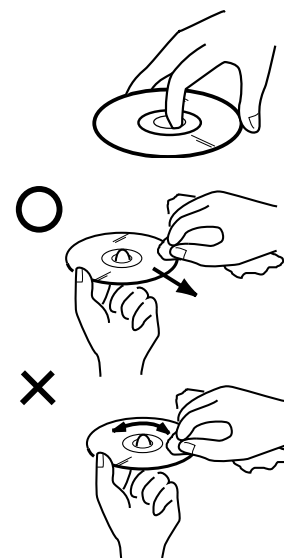

Playing a disc

This section shows you the basics on how to play a disc.

CAUTION

Keep your fingers well clear of the disc tray as it is closing. Neglecting to do so may cause serious personal injury.

Basic playback (DVD/VCD/Audio CD)

Preparation

Make sure that the **POWER** (⏻) switch on the top of the unit is pushed in (ON). (The STANDBY indicator lights up.)

1

Press **TV/DVD** on the remote control to select the DVD mode, or press **INPUT SELECT** and press ▲ or ▼ to select DVD, then press **ENTER**.

2

Place the disc in the disc slot with the label side facing forward. (If the disc has a label.) Hold the disc without touching either of its surfaces, align it with the guides, and place it in position.

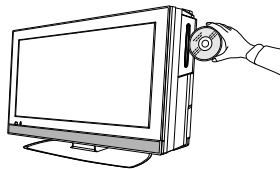

- DO NOT FORCE THE DISC, THIS CAN DAMAGE THE MECHANISM, LIGHTLY PUSH THE DISC UNTIL IT IS ACCEPTED.

3

On the TV-screen, "▲" changes to "Reading" and then playback commences.

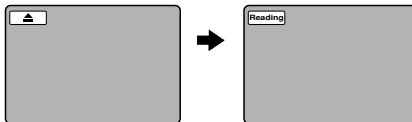

- A menu screen will appear on the TV screen if the disc has a menu feature.
- Press ▲/▼/◀/▶ to select title, then press **ENTER**. Title is selected and play commences.

4

Press ■ to end playback.

- The unit records the stopped point, depending on the disc. "■" appears on the screen. Press **PLAY** (▶) to resume playback (from the scene point).
- If you press ■ again ("■" appears on the screen.), the unit will clear the stopped point.

To start playback in the stop mode

Press **PLAY** (▶).

Note:

- **If the unit does not operate properly:**
Static electricity, etc., may affect the player's operation. Disconnect the AC power cord once, then connect it again.

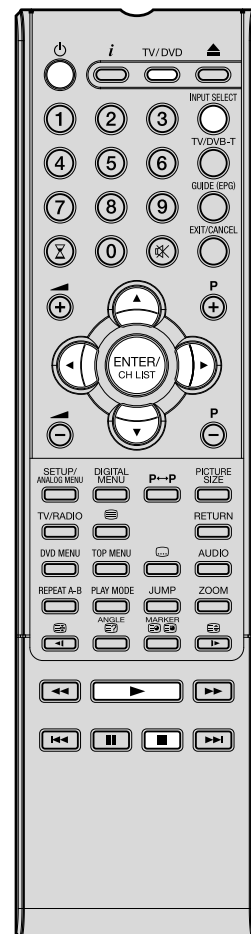

Playing a disc



To pause playback (still mode)

Press **II** during playback.

To resume normal playback, press **PLAY (▶)**.

- The sound is muted during still mode.

To stop playback

Press **■**.

To remove the disc

Press **▲**.

Remove the disc after the disc comes out.

Note:

- If a non-compatible disc is loaded, "Incorrect Disc", "Region Code Error" or "Parental Error" will appear on the TV screen according to the type of loaded disc. In this case, check your disc again (see pages 32 and 50).
- Some discs may take a minute or so to start playback.
- When you set a single-faced disc label backwards (i.e. the wrong way), "Reading" will appear on the display for a few minutes and then "Incorrect Disc" will continue to be displayed.
- Some discs may not work the resuming facility.
- Resuming cannot function when you play a PBC-featured Video CD while the PBC is on. To turn off the PBC, see page 32.
- Some playback operations of DVDs may be intentionally fixed by software producers. Since this unit plays DVDs according to the disc contents the software producers designed, some playback features may not be available. Also refer to the instructions supplied with the DVDs.
- Do not move the unit during playback. Doing so may damage the disc.
- In many instances, a menu screen will appear after playback of a movie is completed. Prolonged display of an on-screen menu may damage your television set, permanently etching that image onto its screen. To avoid this, be sure to press **POWER (⏻)** on your remote control once the movie is completed.
- There may be a slight delay between the button is pressed and the function activates.

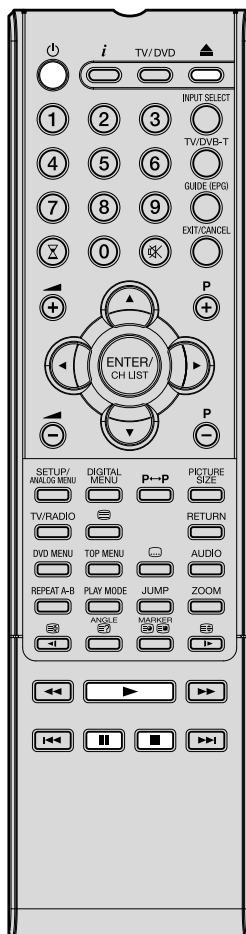

Playing a disc

You can play discs at various speeds.

Playing in fast reverse or fast forward directions (DVD/VCD/Audio CD)

Press ◀◀ or ▶▶ during playback.

◀◀: Fast reverse playback

▶▶: Fast forward playback

Each time you press ◀◀ or ▶▶, the playback speed changes.

To stop playback

Press ■.

Note:

- The unit mutes sound during reverse and forward scan of DVD/VCD/Audio CD discs.
- The playback speed may differ depending on the disc.

Playing frame by frame (DVD/VCD)

Press ⏮ during still playback.

Each time you press ⏮, the picture advances one frame.

To resume normal playback

Press **PLAY** (▶).

Note:

- The sound is muted during frame by frame playback.

Playing in slow-motion (DVD/VCD)

Press ◀| or |▶ during playback.

Each time you press ◀| or |▶, the slow-motion speed changes.

To resume normal playback

Press **PLAY** (▶).

Note:

- The sound is muted during slow-motion playback.
- Reverse slow (◀|) does not work on VCD.

Locating a chapter or track (DVD/VCD/Audio CD)

Press ◀◀ or ▶▶ repeatedly to display the chapter or track number you want.

Press ▶▶ to playback starts from the selected chapter or track.

Press ◀◀ to locate succeeding chapters or tracks.

Playback starts from the beginning of the current chapter or track.

Note:

- A prohibition symbol "x" may appear at the upper right of the screen. This symbol means either the feature you tried is not available on the disc, or the unit cannot access the feature at this time. This does not indicate a problem with the unit.

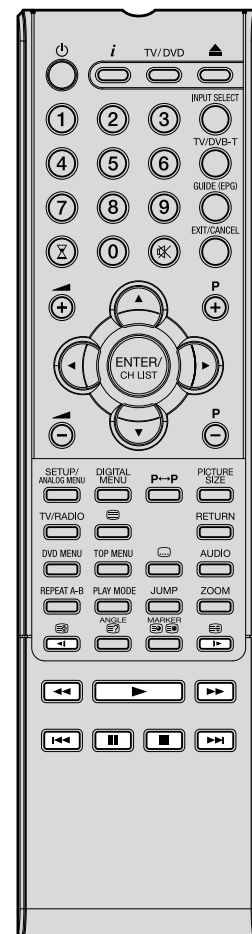

Zooming/Locating Desired Scene



Zooming (DVD/VCD)

This unit will allow you to zoom in on the frame image. You can then make selections by switching the position of the frame.

1

Press **ZOOM** during playback.

The centre part of the image will be zoomed in. Each press of **ZOOM** will change the ZOOM Q 1 (x 1.3), Q2 (x 1.5) and Q3 (x 2.0).

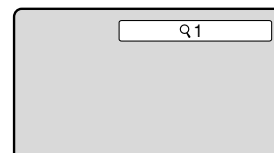

2

Press **▲/▼/◀/▶** to view a different part of the frame. You may move the frame from the centre position to UP, DOWN, LEFT or RIGHT direction.

3

In the zoom mode, press **ZOOM** repeatedly to return to a 1:1 view (Q Off).

Note:

- You can select the Pause or Slow in the zoom mode.
- Some discs may not respond to zoom feature.

Locating Desired Scene (DVD/VCD/Audio CD)

Use the title, chapter and time recorded on the DVD disc to locate the desired point to playback. In the case of VCD/Audio CD discs, time and track are used to locate the desired point to playback. To check the title, chapter/track and time, press **i**.

1

Press **JUMP** during playback or resume stop mode.

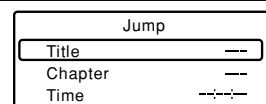

2

Press **▲** or **▼** to select the "Title /Track", "Chapter" or "Time".

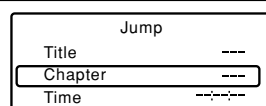

3

Press **Number buttons (0-9)** to input the number.

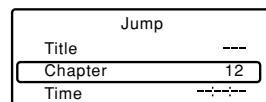

- If you input a wrong number, press **CANCEL**.
- Refer to the package supplied with the disc to check the numbers.

4

Press **ENTER**. Playback starts.

- When you change the title, playback starts from Chapter 1 of the selected title.
- Some discs may not work in the above operation.

Note:

- In case of the Audio CD and Video-CD, only Track and Time can be selected.
- In case of the Video-CD playback with PBC, the JUMP does not work. Turn off the PBC (see page 32).

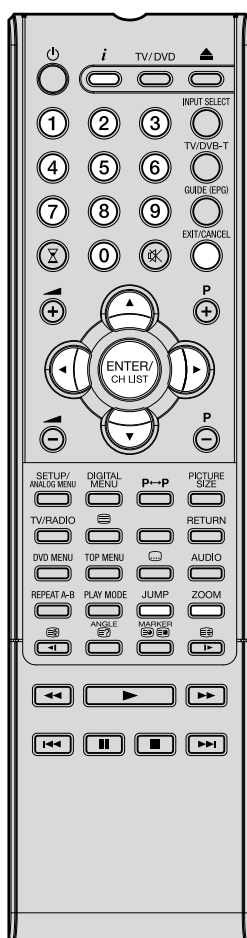

Marking desired scenes

Marking the scenes (DVD/VCD/Audio CD)

The unit stores the points that you want to watch again up to 3 points. You can resume playback from each scene.

1

Press **MARKER** during playback.

Marker 1	--- : --- : ---
Marker 2	--- : --- : ---
Marker 3	--- : --- : ---

2

Select the blank Marker using **▲** or **▼**. Then press **ENTER** at the desired scene.

Marker 1	00 : 27 : 54
Marker 2	--- : --- : ---
Marker 3	--- : --- : ---

- Repeat this procedure to set the other 2 scenes.

3

Press **MARKER** to clear this display.

Returning to the scenes (DVD/VCD/Audio CD)

1

Press **MARKER** during playback or stop mode.

Marker 1	00 : 27 : 54
Marker 2	01 : 16 : 25
Marker 3	02 : 08 : 31

2

Press **▲** or **▼** to select the Marker 1-3.

Marker 1	00 : 27 : 54
Marker 2	01 : 16 : 25
Marker 3	02 : 08 : 31

3

Press **ENTER**.

Playback starts from the marked scene.

To cancel the Marker

Follow the above steps 1~2, then press **CANCEL**.

Note:

- Some discs may not work with the marking operation.
- The marking is cancelled when you eject the disc or turn the power off.
- Some subtitles recorded around the marker may fail to appear.
- In case of Video CD with PBC, Marker function is prohibited.
- Marker function does not work with MP3/JPEG CD.

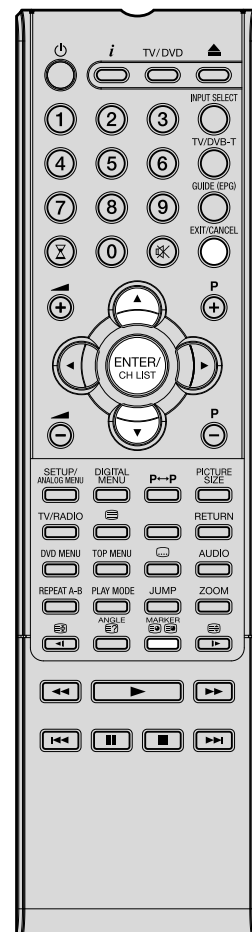

Repeat Playback/A-B Repeat Playback



Repeat playback (DVD/VCD)

1

Press **PLAY MODE** during playback or stop mode.

2

Press **ENTER** repeatedly to select "Chapter" or "Title".

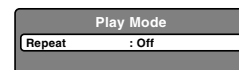

The unit automatically starts repeat playback after finishing the current title or chapter.

[Video CD]

Press **▼** to select "Repeat".

Press **ENTER** to select "Track" or "All".

- If you set the repeat mode during stop mode, press **PLAY (▶)** to start Repeat playback.

3

Press **PLAY MODE** again to clear the screen.

To resume normal playback

Select Repeat : "Off" in step 2.

Note:

- Some discs may not work with the repeat operation.
- In case of Video CD with PBC, Repeat functions are prohibited during playback.
- Chapter/Track repeat function is cancelled whenever **SKIP (◀◀)** or **SKIP (▶▶)** is pressed.

A-B Repeat Playback (DVD/VCD/Audio CD)

A-B repeat playback allows you to repeat selection between two selected points.

1

Press **REPEAT A-B** during playback.
The start point is selected.



2

Press **REPEAT A-B** again.

The end point is selected. Playback starts at the point that you selected.
Playback stops at the end point and returns to Point A automatically, then starts again.



To resume normal playback

Press **REPEAT A-B** again.

"Off" appears on the screen.

Note:

- In A-B Repeat mode, subtitles near the A or B locations may not be displayed.
- You may not be able to set A-B Repeat for the scenes that include multiple angles.
- A-B Repeat playback does not work when Repeat playback is activated.
- You may not be able to set A-B Repeat during certain scenes of the DVD.

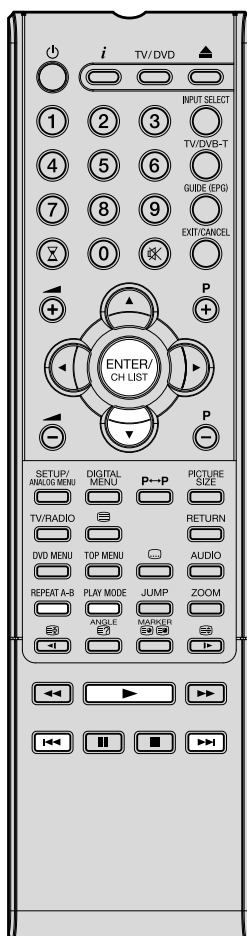

Changing Angles/Title Selection/DVD menu

Changing Angles (DVD)

When playing back a disc recorded with multi-angle facility, you can change the angle that you are viewing the scene from.

1

Press **ANGLE** during playback.
The current angle will appear.

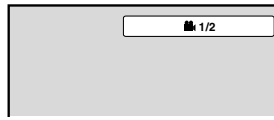

2

Press **ANGLE** repeatedly until the desired angle is selected.

Note:

- Depending on the DVD, you may not be able to change the angles even if multi-angles are recorded on the DVD.

Title Selection (DVD)

Two or more titles are recorded on some discs. If the title menu is recorded on the disc, you can select the desired title.

1

Press **TOP MENU** during playback.
Title menu appears on the screen.

2

Press **▲/▼/◀/▶** to select the desired title.

3

Press **ENTER** or **PLAY (▶)**.
The playback of the selected title will start.

Note:

- Depending on the DVD, you may not be able to select the title. Depending on the DVD, a "title menu" may simply be called a "menu" or "title" in the instructions supplied with the disc.

DVD menu (DVD)

Some DVDs allow you to select the disc contents using the menu. When you playback these DVDs, you can select the subtitle language and soundtrack language, etc. using the menu.

1

Press **DVD MENU** during playback.
The DVD menu appears on the screen.

- Press **DVD MENU** again to resume playback at the scene when you pressed **DVD MENU**.

2

Press **▲/▼/◀/▶** to select the desired item.

3

Press **ENTER**.
The menu continues to another screen. Repeat steps 2 and 3 to set the item completely.

Note:

- Depending on the DVD, you may not be able to resume playback from the scene point when you press **DVD MENU**.

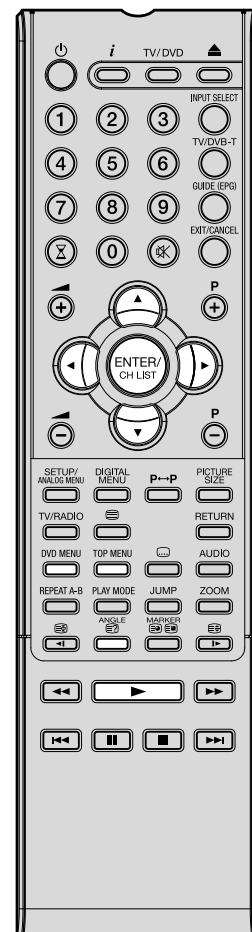

Changing Soundtrack Language/Subtitles/Disc Status

Note:

- If the desired language is not heard after pressing the button several times, the language is not recorded on the disc.
- The selected soundtrack language is cancelled when you eject the disc. The initial default language or available language will be heard if the disc is played back again.
- If you select DTS in playing DTS-encoded disc, no sound will be heard.
- Depending on the DVD, you may not be able to change subtitles, or to turn subtitles on or off.
- While playing a DVD, the subtitle may change when you loaded or eject the disc.
- In some cases, a selected subtitle language may not be changed immediately.

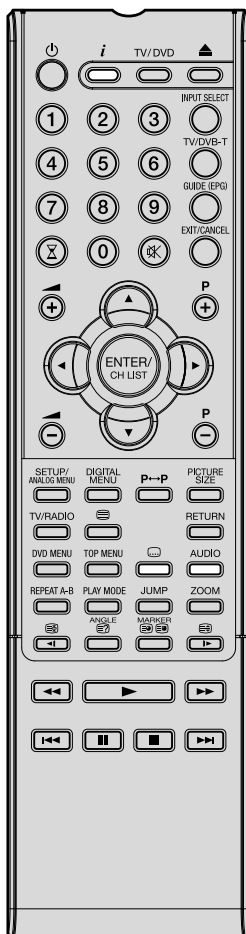

Changing Soundtrack Language (DVD/VCD)

You can select the language when you play a multilingual disc.

1

Press **AUDIO** during playback.
The current soundtrack language will appear.

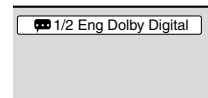

2

Press **AUDIO** repeatedly until the desired language is selected.

- The on screen display will disappear after a few seconds.

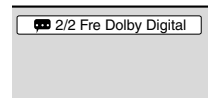

In case of Video CD playback

Audio type changes as follows each time you press **AUDIO**.



Subtitles (DVD)

When playing back a disc recorded with subtitles, you can select the subtitle language or turn the subtitle off.

1

Press **⏏** repeatedly during playback until the desired language is selected.

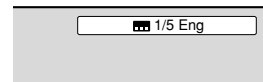

2

To turn off the subtitle, press **⏏** until "Off" appears.

- The on screen display will disappear after a few seconds.



Disc status

With press of **i**, the status of the disc will appear on the screen.

To cancel the display, press **i** again.

[Video CD]

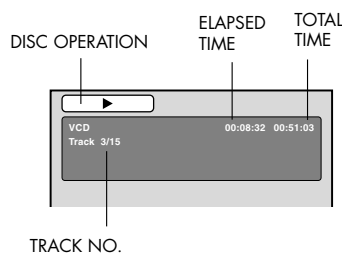

[DVD]

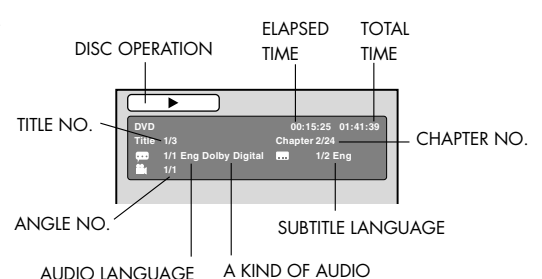

MP3/WMA/JPEG and Audio CD operation

This unit can playback the MP3/WMA/JPEG-data which has been recorded on CD-R/RW. Audio CD also can be played back. To produce the MP3/WMA/JPEG-data, you need a Windows-PC with CD-RW drive and a MP3/WMA/JPEG-encoding Software (not supplied). The Apple-HFS-System cannot be played.

This unit requires discs/recordings to meet certain technical standards in order to achieve optimal playback quality. There are many different types of recordable disc formats (including CD-R containing MP3/WMA files). Not all recordable discs will produce optimal playback quality. The technical criteria set forth in this instruction manual are meant only as a guide. Use of CD-RW for MP3 files is not recommended.

MP3/WMA/JPEG - data information

Limitations on MP3/WMA/JPEG playback

- MP3/WMA/JPEG CD are standardized by ISO9660, its file name must include following extensions; ".mp3", ".wma", ".jpg".
- MP3/WMA/JPEG CD must be corresponded to the ISO standardized files.
- This unit can read 2000 files per disc. If one disc has more than 2000 files, it reads up to 2000 files, the remaining files will be omitted.
- MP3/WMA/JPEG CDs cannot be used for the purpose of recording on this unit.
- If the CD has both CDA audio tracks and MP3/WMA/JPEG files, only the CDA audio tracks will be played.
- It may take more than one minute for this unit to read MP3/WMA/JPEG files depending on its structure.
- Music recorded by "Joliet Recording Specification" can be played back.
- The music files recorded by "Hierarchical File System" (HFS) cannot be played.

Limitations on displaying of the file name.

- The maximum number for display is 15 characters. Long file names will be condensed.
- Available characters for display are the following:
capital or small alphabets of A through Z, numbers of 0 through 9, and _ (under score).
- Other characters than those above are replaced in hyphen.

To playback MP3/WMA/JPEG CD in the recorded order.

1. Use MP3/WMA/JPEG software that records data alphabetically or numerically.
2. Insert two or three digit number in the head of file name. (ex. "01" "02" or "001" "002").
3. Refrain from making too many sub-folders.

CAUTION:

- Some MP3/WMA/JPEG CDs cannot be played back depending on the recording conditions.
- The CD-R/RW that has no music data or non MP3/WMA/JPEG files cannot be played back.

Standard sampling frequency and the bit rate:

MP3

MPEG-1 Audio

32kHz, 44.1kHz, 48kHz

32kbps ~ 320kbps (constant bit rate or variable bit rate)

The recommend recording setting for a high-quality sound is 44.1kHz of sampling frequency and 128kbps of constant bit rate.

WMA

WMA version 7 and 8

32kHz/48kbps, 44.1kHz/48kbps~192kbps, 48kHz/128kbps~192kbps

The file recorded by mono, 48kHz, 48 kbps is not available to this unit.

MP3/WMA/JPEG and Audio CD operation



Loading CD

1

Load a MP3/WMA/JPEG CD or an Audio CD into the disc slot.

2

A file browser screen will appear on the screen.

- In case the current directory includes 9 files or more, press ▲ or ▼ to scroll in the file list.
- To see contents in folder, select the folder and then press **ENTER**. To return to the parent directory, select "Go Up ..." then press **ENTER**.
- In case of a CD containing a mixture of MP3, WMA and files, the files are played back by selecting them from the file browser.

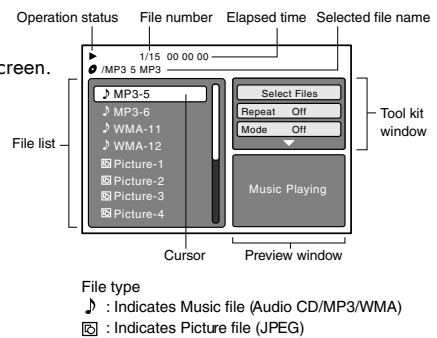

MP3/WMA and Audio CD playback

1

In the file browser, press ▲/▼ to select the desired file.

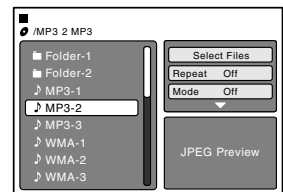

When **PLAY** (▶) is pressed after displaying file browser displayed, or when the disc tray is closed by pressing **PLAY** (▶), playback begins automatically starting from the first file. In this case, if the first file is an MP3/WMA file, only MP3/WMA files are played back in order. If the first file is a JPEG file, the first JPEG file is played back. If there is no file at a root directory, playback does not begin automatically.

2

Press **ENTER**.

The selected file starts playing back.

3

Press ■ to end playback.

The selected file starts playing back.

- The unit records the stopped point. "■" appears on the screen. Press **PLAY** (▶) to resume playback (from the scene point).
- If you press ■ again or unload the disc, the unit will clear the stopped point.

Note:

- MP3 or WMA file on the Kodak Picture CD is not recognized on this unit.
- During MP3/WMA/JPEG-Playback, you cannot use JUMP and A-B Repeat functions.
- You can use Repeat (Track or All), Random functions and Program playback for MP3/WMA/JPEG-Playback (See pages 44,45)

Select Files

The file type to make it display in the file browser can be chosen.

1. Press ◀ or ▶ to select "Select Files" at right column in the file browser.
 - Press **ENTER**, then press ▲ or ▼ to select file type from the list (Music or Picture).
1. Press **ENTER** to add/remove check mark. Checked file type will be displayed in the file browser.
2. Press **RETURN** to save the setting.

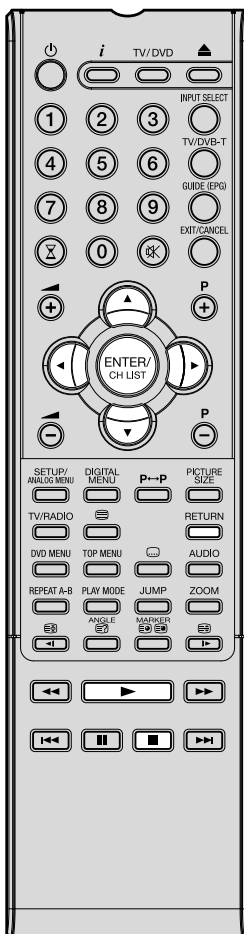

MP3/WMA/JPEG and Audio CD operation

JPEG playback

1

In the file browser, press ▲/▼ to select the desired JPEG file.
To display a thumbnail list, press **DVD MENU**.
Press ▲/▼/◀/▶ to select the desired file.
(To return to the file browser, press **TOP MENU**.)

When **PLAY (▶)** is pressed after displaying the file browser, or when the disc tray is closed by pressing **PLAY (▶)**, playback begins automatically starting from the first file. In this case, if the first file is a JPEG file, the first JPEG file is played back. If the first file is an MP3/WMA file, only MP3/WMA files are played back in order. If there is no file at a root directory, playback does not begin automatically.

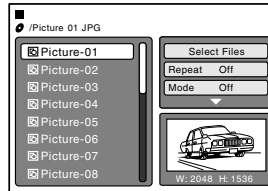

2

Press **ENTER**. The selected picture appears on the screen.

Rotating an image

You can rotate an image by 90 degrees.
Press **ANGLE** during playback of the image.
"↶", "↷", "↵", "↷" or "↶" appears on the screen.

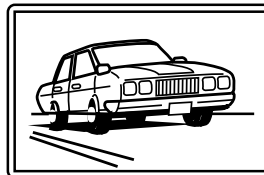

Zooming an image

Zoom function also can be used in viewing JPEG files. Press **ZOOM** (See "Zooming" on page 36).

3

Press ■ to end playback.
The file browser appears on the screen. If you want to watch the other file, repeat steps 1 ~ 2.

Slide show playback

The slide show enables you to view pictures (files) one after another automatically.

Preparation

Set "JPEG Interval" setting to "5 Seconds", "10 Seconds" or "15 Seconds" (See page 49).

1

Select your desired starting file for the slide show in step 1 on the above column.

2

Press **ENTER** or **PLAY (▶)** to start slide show from the selected file.

- If you press **||** during the slide show, the slide show stops temporary. "||" appears briefly on the screen.
- If the picture appears upside down or sideways, press **ANGLE** repeatedly until it's right side up. "↶", "↷", "↵", "↷" or "↶" appears on the screen.
- Press **PLAY (▶)** or **SKIP (▶▶)** again to resume the slide show.
- When the slide show playback finished, the file list appears.
- To stop the slide show, press ■. The file list appears.

Note:

- During JPEG playback, you cannot use Jump and A-B Repeat functions.
- When an image exceeds 5760 x 3840 pixels, the entire image (preview window or thumbnail list) may not be displayed on a screen.
- It may have a longer interval due to the size of data.

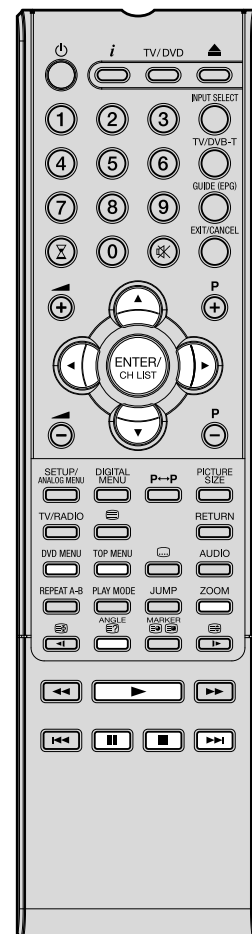

MP3/WMA/JPEG and Audio CD operation

Note:

- The repeat or random function is canceled when you eject the disc or turn the power off.
- The track repeat function is canceled when ◀◀ or ▶▶ is pressed.
- In case of Audio CD, the function of A-B Repeat also can be used. See "A-B Repeat playback" (See page 38).

Repeat playback (Audio CD/MP3/WMA/JPEG)

1

In the file browser, press ▲/▼/◀/▶ to select "Repeat" during stop mode.



2

Press **ENTER** repeatedly to select "Track" or "All".



3

Press **PLAY** (▶).

The unit automatically starts repeat playback after finishing the current track.

To resume normal playback

Select Repeat : "Off" in step 2.

Random playback (Audio CD/MP3/WMA/JPEG)

1

In the file browser, press ▲/▼/◀/▶ to select "Mode" during stop mode.

2

Press **ENTER** to select "Random".



3

Press **PLAY** (▶).

The Random playback will start.

To resume normal playback

Select Repeat : "Off" in step 2.

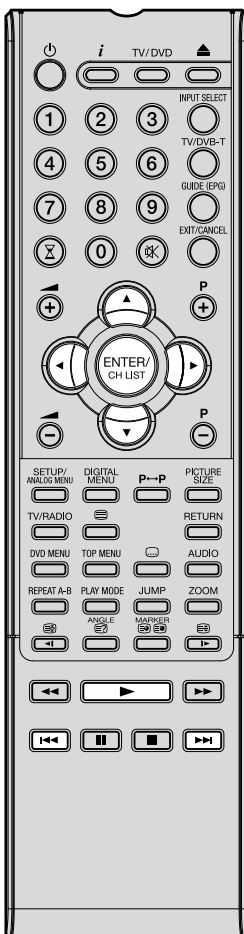

MP3/WMA/JPEG and Audio CD operation

Program playback (Audio CD/MP3/WMA/JPEG)

1

In the file browser, press ▲/▼/◀/▶ to select "Edit Mode", then press **ENTER**.



When "Edit Mode" is black color, you can mark the files which you want to add into Program list.

2

Press ▲/▼/◀/▶ to select the file you want to add into the program list.



Press **ENTER**. Selected file was marked.

Repeat this procedure to select the other files.

3

Press ▲/▼/◀/▶ to select "Add To Program". Then press **ENTER**. All marked files are added into the program list.



When you finish storing the files you want into the Program list, select "Edit Mode" again and press **ENTER** to release edit mode.

4

Press ▲/▼ to select "Program View", then press **ENTER**. Program View shows only the programmed files that you have added in Step 2.

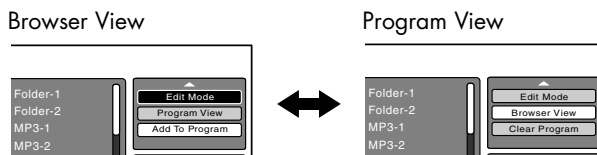

5

In the Program View, press **PLAY (▶)**. The files start to playback in programmed order that were added by you.

To remove file from program list in stop mode

In the Edit Mode, switch to Program View. Select the files you want to remove, then press **ENTER**. Select "Clear Program" and press **ENTER**. Marked file is removed from program list.

Note:

- The program function is canceled when you eject the disc or turn the power off.

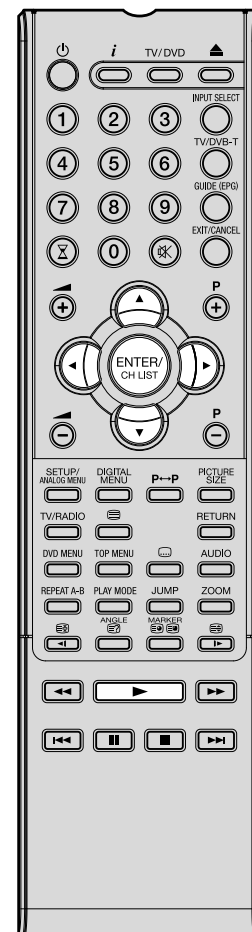

Program playback/Random playback

Note:

- In case of Video CD with PBC, you cannot set Program playback.
- The program is cancelled when you eject the disc or turn the power off.
- In case of Video CD with PBC, you cannot set Random function during playback.

You can arrange the playback order of tracks or files on the disc. And the unit can also select tracks or files at random and playback them. These feature works for Video CD.

For Audio CD and MP3/WMA/JPEG CD, please see "Random playback (Audio CD/MP3/WMA/JPEG)" on page 44 and "Program playback (Audio CD/MP3/WMA/JPEG)" on page 45.

Program playback (VCD)

1

Press **PLAY MODE** during stop mode.

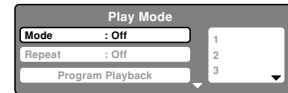

2

Press **▲/▼** to select "Mode", then press **ENTER** to select "Program".



3

Press **◀/▶** to select the programming position. Use **Number buttons (0-9)** to input the track numbers on sequentially.



- If you input a wrong number, press **CANCEL**.

4

Press **◀/▶** to return to the left column, then press **▲/▼** to select the "Program Playback" and press **ENTER**.



The programs you selected will start to playback in order.

- To resume normal playback, select Mode "Off" in step 2.

To change the program

1. Select Mode to "Program" (as step 2), press **◀/▶/▲/▼** to select the track number you want to change, then press **CANCEL**.
2. Press **Number buttons (0-9)** to overwrite the new track number.

To clear the program one by one

Select Mode to "Program", press **◀/▶/▲/▼** to select the track number. Then press **CANCEL**.

To clear all the programs

In the above column, press **▲/▼** to select "Clear Program". Then press **ENTER**.

Random playback (VCD)

1

Press **PLAY MODE** during playback or stop mode.

2

Press **▲/▼** to select "Mode", then press **ENTER** to select "Random".

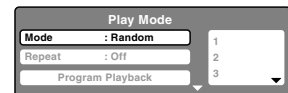

3

Press **PLAY (▶)**.

The Random Playback will start.

- If you set "Random" during playback mode, Random playback will begin after the track that is currently being played has ended.
- To resume normal playback, select Mode "Off" in step 2.

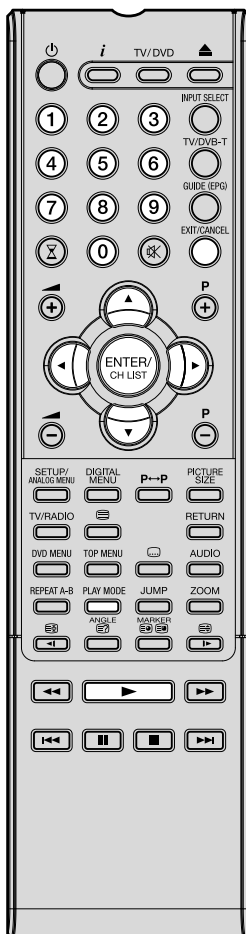

Customizing The Function Settings

You can change the default settings to customize performance to your preference.

Setting procedure

1

Press **SETUP** in stop mode.

The following on-screen display appears.

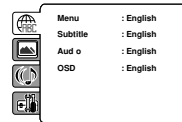

2

Press **▲** or **▼** to select the desired section, then press **▶** or **ENTER**.

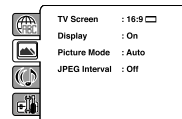

3

First option will be highlighted. Press **▲** or **▼** to select the desired option.

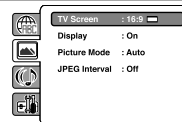

4

Then press **▶** or **ENTER**. The selectable settings will appear.

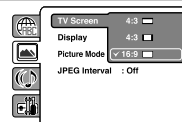

5

Change the selection using **▲** or **▼**, by referring to the corresponding pages 48 ~ 50.

Press **ENTER** to save the setting.

- Repeat steps 3 and 5 to change other option.
- To select another section, go back to step 2 by pressing **◀** or **RETURN** repeatedly.

6

To clear SETUP screen, press **SETUP** or press **RETURN** repeatedly.

Setting details

Section	Option	Details	Page
	Menu Subtitle Audio	To select the language of "Menu", "Subtitle" and "Audio" if more than one languages are available on the disc.	48
	OSD	To select a preferred language for on screen display.	
	TV Screen	To select a picture size according to the aspect ratio of your TV.	49
	Display	To turn On or Off the operational status display on the screen.	
	Picture Mode	To select a preferred picture mode from "Video", "Film" or "Auto".	
	JPEG Interval	To select a preferred setting for the slide show playback.	
	Night Mode	To select On or Off for Night Mode.	50
	Digital Out	To select a digital output sound format corresponding to your system connection.	
	Parental	To select a preferred parental level for the parental setting.	50
	Password	To change the password.	

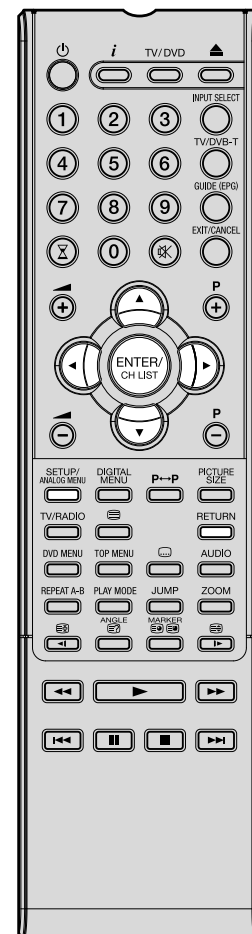

Customizing The Function Settings



Menu, Subtitle, Audio

You can select the language of "Menu", "Subtitle" and "Audio" if more than one language is recorded onto the disc.

English, Deutsch, Русский, Italiano, Espanol:

The selected language will be heard or seen.

Other:

Other languages can be selected (see "Language code list" on page 52).

Off (Subtitle):

Subtitles do not appear.

Original (Audio):

The unit will select the first priority language of each disc.

Note:

- If the selected language is not recorded on the disc, the first-priority language is selected.

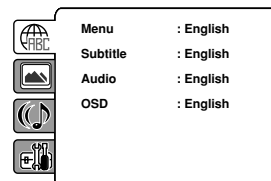

OSD

The setup language can be selected.

- English:** To display OSD language is English
- Deutsch:** To display OSD language is German
- Русский:** To display OSD language is Russian
- Italiano:** To display OSD language is Italian
- Espanol:** To display OSD language is Spanish



TV Screen

You have the following screen sizes to choose from:

4:3 (Letterbox)

When playing back a wide screen-DVD disc, it displays the wide picture with black bands at the top and bottom of screen.

4:3 (Panscan)

It displays the wide picture on the whole screen with left and right edges automatically cut off.

16:9 (Wide screen)

A wide screen picture is displayed full size.

Note:

- If the DVD disc is not formatted in the pan & scan style, it displays 4:3 style.

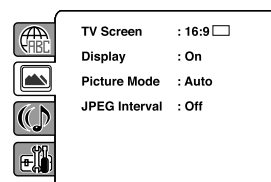

Display

On screen display can be switched on or off when you press any buttons.

Off: On screen displays do not appear when you press any buttons.

On: On screen displays appear when you press the buttons (factory setting).

Customizing The Function Settings

Picture Mode

There are two types of source content in pictures recorded in DVD video discs: film content (pictures recorded from films at 24 frames per second) and video content (video signals recorded at 30 frames per second). Make this selection according to the type of content being viewed.

- Auto:** Select this selection normally.
The DVD player automatically detects source content, film or video of playback source, and converts that signal in an appropriate method.
- Film:** The DVD player converts film content pictures appropriately. Suitable for playback of film content pictures.
- Video:** The DVD player filters video signal, and converts it appropriately. Suitable for playback of video content pictures.

Note:

- Depending on the disc, pictures may be cut off or doubled. In this case, select "Video".

JPEG Interval

You can continuously playback all JPEG files automatically. After the selection below, the disc will start playback on JPEG files which have been recorded.

- Off:** Plays back one file at a time.
- 5 Seconds:** Plays back images in the form of a slide show at 5 second intervals.
- 10 Seconds:** Plays back images in the form of a slide show at 10 second intervals.
- 15 Seconds:** Plays back images in the form of a slide show in 15 second intervals.

Night Mode

Night Mode enables you to control the dynamic range so as to achieve a suitable sound for your equipment.

- Off:** It plays back at the recording level on the disc.
- On:** Loud sound such as explosion is toned down slightly when played back. This is suitable when it is connected to a stereo.

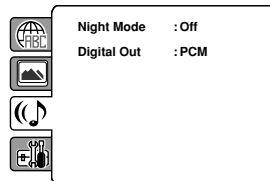

Note:

- This function works only when the disc recorded with Dolby Digital is played back.
- The level of Night Mode may differ depending on DVD video disc.

Digital Out

You can select the digital output sound format corresponding to your system connection.

- Off:** There is no sound output from DIGITAL AUDIO OUT jack.
- PCM:** Change Dolby Digital to PCM for the output.
Select when connected to a 2 channel digital stereo amplifier.
- Bitstream:** Disc audio bitstream data will be output.

Note:

- Even if you select "Bitstream", MPEG Audio will be output in PCM format.



Customizing The Function Settings



Note:

- If each setup (pages 48 ~ 50) has been completed, the unit can always work under the same condition (especially with DVD discs). Each setup will be retained in the memory even if you turn the power off.

Parental

Some discs are specified as not suitable for children. Such discs can be limited not to playback with the unit.

- 1) Press **▲** or **▼** to select "Parental", then press **ENTER**. "Enter Password" screen will appear.
- 2) Press "0000" using **Number buttons (0-9)**. (Please note, this is pre-setting password of this unit). Then press **ENTER**. The parental level list will appear.
 - **Level 1:** DVD software for adults cannot be played back.
 - **Level 8:** Virtually all DVD software can be played back.
 - **Level Off:** The parental control setting does not function.
- 3) Press **▲** or **▼** to select from the level 1 to level 8. The limitation will be more severe as the level number is lower. Then press **ENTER**.
- 4) Press **▲** to activate Parental control setting.

Note:

- Depending on the discs, the unit cannot limit playback.
- Some discs may not be encoded with specific rating level information though its disc jacket says "adult." For those discs, the age restriction will not work.
- The password is required every time when you change the parental level.
- If you input a wrong number, press **CANCEL**.

Password

- 1) Press **▲** or **▼** to select "Password", then press **ENTER**. "Enter Current Password" screen will appear.
- 2) Press **Number buttons (0-9)** to input the current password (If the password has not been set yet after you purchase this unit, it is "0000").
- 3) Then press **ENTER**. "Enter New Password" screen will appear. Press **Number buttons (0-9)** to input the new password.
- 4) Press **ENTER**. Now your new password has been set. Be sure to remember this number!

If you forget the password.

- 1) Press **▲** to remove the disc.
- 2) While holding **7** down on the remote control and at the same time press **STOP (DVD)** on the top panel. "Password Clear" appears on the screen. Now the password has been returned to the initial value ("0000").

Temporary Cancel The Rating Level By DVD Disc

Depending on the DVD disc, the disc may try to temporarily cancel the rating level that you have set. It is up to you to decide whether to cancel the rating level or not.

1

Load a DVD disc.

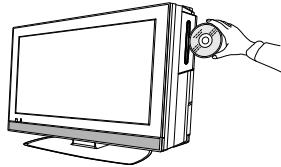

2

If the DVD disc has been designed to temporarily cancel the Rating level, the screen which follows the "Reading" screen will change, depending on which disc is played. If you select "YES" with the **ENTER** key, password input screen will then appear.

3

Enter the password with **Number buttons (0-9)**. Then press **ENTER**.

To exit from the entry, press **RETURN**.



4

Playback will commence if the entered password was correct.

Note:

- This temporary cancellation of rating level will be kept until the disc is ejected. When the disc is ejected, the original rating level will be set again automatically.

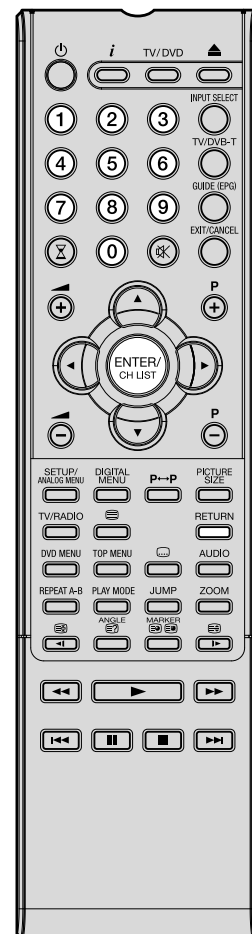

Language Code List

Enter the appropriate code number for the initial settings "Menu", "Subtitle" and/or "Audio" (see pages 48).

Language Name	Code	Language Name	Code	Language Name	Code	Language Name	Code
Abkhazian	1112	Fiji	1620	Lingala	2224	Singhalese	2919
Afar	1111	Finnish	1619	Lithuanian	2230	Slovak	2921
Afrikaans	1116	French	1628	Macedonian	2321	Slovenian	2922
Albanian	2927	Frisian	1635	Malagasy	2317	Somali	2925
Amharic	1123	Galician	1722	Malay	2329	Spanish	1529
Arabic	1128	Georgian	2111	Malayalam	2322	Sundanese	2931
Armenian	1835	German	1415	Maltese	2330	Swahili	2933
Assamese	1129	Greek	1522	Maori	2319	Swedish	2932
Aymara	1135	Greenlandic	2122	Marathi	2328	Tagalog	3022
Azerbaijani	1136	Guarani	1724	Moldavian	2325	Tajik	3017
Bashkir	1211	Gujarati	1731	Mongolian	2324	Tamil	3011
Basque	1531	Hausa	1811	Nauru	2411	Tatar	3030
Bengali; Bangla	1224	Hebrew	1933	Nepali	2415	Telugu	3015
Bhutani	1436	Hindi	1819	Norwegian	2425	Thai	3018
Bihari	1218	Hungarian	1831	Oriya	2528	Tibetan	1225
Breton	1228	Icelandic	1929	Panjabi	2611	Tigrinya	3019
Bulgarian	1217	Indonesian	1924	Pashto, Pushto	2629	Tonga	3025
Burmese	2335	Interlingua	1911	Persian	1611	Turkish	3028
Byelorussian	1215	Irish	1711	Polish	2622	Turkmen	3021
Cambodian	2123	Italian	1930	Portuguese	2630	Twi	3033
Catalan	1311	Japanese	2011	Quechua	2731	Ukrainian	3121
Chinese	3618	Javanese	2033	Rhaeto-Romance	2823	Urdu	3128
Corsican	1325	Kannada	2124	Romanian	2825	Uzbek	3136
Croatian	1828	Kashmiri	2129	Russian	2831	Vietnamese	3219
Czech	1329	Kazakh	2121	Samoan	2923	Volapük	3225
Danish	1411	Kirghiz	2135	Sanskrit	2911	Welsh	1335
Dutch	2422	Korean	2125	Scots Gaelic	1714	Wolof	3325
English	1524	Kurdish	2131	Serbian	2928	Xhosa	3418
Esperanto	1525	Laothian	2225	Serbo-Croatian	2918	Yiddish	2019
Estonian	1530	Latin	2211	Shona	2924	Yoruba	3525
Faroese	1625	Latvian, Lettish	2232	Sindhi	2914	Zulu	3631

Before Requesting Service

If your unit does not work properly check the following before calling a service engineer.

SYMPTOMS	CAUSE	SOLUTION	PAGE
POWER			
TV does not operate.	Internal error may occurs.	Unplug the unit for 1 minute, then plug it back in.	-
No power.	The Mains lead is disconnected.	Connect the Mains lead to the AC outlet.	3
	Main power (ON) switch is OFF.	Set it to ON.	2
TV BROADCAST RECEPTION			
No picture, no sound.	The Mains lead is disconnected.	Connect the Mains lead to the AC outlet.	3
	Aerial connector is not connected or wires are broken.	Check aerial connections or broken wires.	3
	Sub Power (⏻) button is off.	Press the Sub Power (⏻) button.	2
	Possibly station trouble.	Try another channel.	14
Sound OK, poor picture.	Possibly station trouble.	Try another channel.	14
	Aerial connector is not connected or wires are broken.	Check aerial connections or broken wires.	3
	Possibly local interference.	Move the aerial away from the source of interference.	-
Picture OK, poor sound.	Possibly station trouble.	Try another channel.	14
	Possibly local interference.	Move the aerial away from the source of interference.	-
	Volume control set at minimum position.	Increase VOLUME control.	14
Poor reception.	Aerial connector is not connected or wires are broken.	Check aerial connections or broken wires.	3
	Possibly station trouble.	Try another channel.	14
Poor colour or no colour.	Aerial connector is not connected or wires are broken.	Check aerial connections or broken wires.	3
	Possibly station trouble.	Try another channel.	14
	Possibly local interference.	Move the aerial away from the source of interference.	-
	Colour control is not adjusted.	Adjust the colour settings.	18
While viewing a DVB (digital) channel, there is sound but no picture.	Received channel has audio content only.	Some channel offers audio content only. It is normal.	26
Blocky image or image stops intermittently.	Digital signal strength is low.	Check all aerial connections. Move the aerial away from areas of possible interference. Try using an aerial booster.	-
Some digital channels cannot be viewed.	Some channels are encrypted and are only available via subscription.	Contact the service provider to subscribe.	-
"Database empty" message appears on the screen.	The auto tuning process has not been successful.	Check all aerial connections and try auto tuning again.	3
No sound when connecting to external source via HDMI to DVI lead.	Audio leads have not be connected.	Ensure that separate audio leads are connected to the relevant audio input socket.	9

Before Requesting Service

SYMPTOMS	CAUSE	SOLUTION	PAGE
DVD			
The playback picture has occasional distortion.	The disc is dirty.	Eject the disc and clean it.	32
	It is in fast forward or fast reverse playback.	Some times a small amount of picture distortion may appear. This is not a malfunction.	-
The unit does not start playback.	No disc is inserted.	Insert a disc.	33
	An unplayable disc is inserted.	Insert a playable disc (Check the disc type and colour system).	32
	The disc is placed with the label side facing backward.	Place the disc in the disc slot with the label side facing forward.	33
	The disc is dirty.	Clean the disc.	32
	The parental lock function is set.	Cancel the parental lock function or change the parental lock level.	50
Playback does not follow the course of the disc's program.	It is in the mode of repeat playback, memory playback, etc.	These operations may prevent a proper progress of the contents.	-
X appears on the screen.	The function is prohibited with the unit or the disc.	-	35
REMOTE CONTROL			
Remote control does not work.	It is not aimed at the remote sensor.	Aim it at the remote control sensor.	-
	Distance too far or there is too much light in the room.	Operate within 5 metres and reduce the light of the room.	-
	Obstacle in the path of beam.	Clear the path of the beam.	-
	Batteries are weak.	Replace batteries.	-
	Polarities of the batteries, + or -, are not inserted correctly.	Install batteries correctly.	-

* This product incorporates copyright protection technology that is protected by U.S. patents and other intellectual property rights. Use of this copyright protection technology must be authorized by Macrovision, and is intended for home and other limited viewing uses only unless otherwise authorized by Macrovision. Reverse engineering or disassembly is prohibited.

* Manufactured under license from Dolby Laboratories. "Dolby" and the double-D symbol are trademarks of Dolby Laboratories.

* "DTS" and "DTS Digital Out" are registered trademarks of DTS, Inc.

* Unauthorized recording of copyrighted television programs, films, video cassettes and other materials may infringe the rights of copyright owners and be contrary to copyright laws.

Specifications

<p>TELEVISION</p> <p>System:</p> <p>Preset channels: Frequency Range:</p> <p>LCD:</p> <p>Terminals</p> <p>Audio Output Power:</p> <p>DVD</p> <p>Signal system: Applicable disc: Frequency response: S/N Ratio: Harmonic distortion: Output:</p> <p>Pickup:</p> <p>GENERAL</p> <p>Power Source: Power Consumption: Weight: Dimensions: Operating Temperature:</p> <p>REMOTE CONTROL UNIT</p> <p>Power Supply:</p>	<p>Analogue: PAL UK, IR, CCIR, FRENCH System, B/G, D/K, I/I, L Digital: DVB-T (OFDM 2k/8k 16QAM/64QAM) AV Input receivable: NTSC 3.58, NTSC 4.43/PAL 60 Analogue channels (99) + Digital channels (Carrier 200/Service1000) Analogue: IreE2~E4, X~Z+2, S1~S10, E5~E12, S11~S41, E21~E69 Digital: E5~E12, ItaE~G, F1~F6, Rus6~12, E21~E69 18.95" TYPE (48.14 cm visible) TFT low-glass Active Matrix Colour LCD, 1440 x 900 Pixel Viewing Angle:Left/Right: 80 degree, Up/Down: 80 degree Antenna input: UHF/VHF 75 Din type (Analogue Digital) AV1: SCART (AV input, RGB input, TV output) AV2: S-VIDEO (Y/C input), RCA pin (AV input) COMPONENT: COMPONENT (Y/PB (CB)/PR (CR) input), RCA (Audio input) HDMI: HDMI, Ø 3.5 mm jack (Audio input*) PC: Ø 3.5 mm jack (Audio input*), 15 pin mini D-sub (PC/Component) C. I. (Common Interface): EN50221 DIGITAL AUDIO OUTPUT: RCA pin (Audio) Headphones: Ø 3.5 mm jack (Audio output) * Audio input that share with HDMI and PC. 1.5W x 2 (MAX)</p> <p>NTSC, PAL DVD (12cm, 8cm), CD (12cm, 8cm) DVD: 4Hz - 22KHz, CD: 4Hz - 20KHz 85dB 0.02% Audio : (RCA) -12.0 dBm, 1 k Digital Audio : 0.5Vp-p/75 CD : Wavelength: 775 - 805 nm Maximum output power: 0.5 mW DVD : Wavelength: 640 - 660 nm Maximum output power: 1.0 mW</p> <p>AC 220-240V, 50Hz 60 W 6.7 kg 483(W)x396(H)x190(D)mm 5°C to 40°C</p> <p>DC 3V (Two batteries, AA/ R6/ UM-3)</p>
--	--

Weight and Dimensions are approximate. Because we continually strive to improve our products we may change specifications and designs without prior notice.

After Sales Service

Whilst Orion products have been designed and manufactured to a very high standard and have been subjected to rigorous quality control, regrettably problems can sometimes occur.

In the unlikely event of a manufacturing defect occurring during the first twelve months of ownership, your Dealer, Mail Order or Catalogue Company, from whom you purchased the product, will arrange for free-of-charge service to be carried out. However as this may NOT include a home visit, please ensure that you have received details of their respective service procedures and policy at the time of purchase.

Free-of-charge service covers the product for domestic use only, and does not cover any fault or defect caused by accident, misuse, lightning strike, fire or water damage, neglect, connection to an incorrect mains voltage or inadequate aerial, cable or satellite installation.

None of the foregoing comments or statements affect your Statutory Rights as currently provided for by law in the United Kingdom.

**Partmaster
Direct**

Visit Partmaster.co.uk today for the easiest way to buy electrical spares and accessories.
With over 1 million spares and accessories in stock we can deliver direct to your door the very next day.

Visit www.partmaster.co.uk

or call

0870 6001 338

(UK customers only)

Calls charged at National Rate.



Electrical and electronic equipment should never be disposed of with general household waste but must be separately collected for their proper treatment and recovery.

The crossed out bin symbol, placed on the product, reminds you of the need to dispose of the product correctly at the end of its life.

In this way you will assist in the recovery, recycling and reuse of many of the materials used in this product.

Where possible recycle your packaging.

With your help it is possible to reduce the amount of electrical and electronic waste ending up in landfill and to improve quality of life by preventing the release of potentially hazardous substances into the environment.



J50A0201A SH 07/11